

## **Section 6**

# **Particulate Matter Controls**

## **Chapter 2**

# **Wet Scrubbers for Particulate Matter**

Daniel Mussatti  
Innovative Strategies and Economics Group  
Air Quality Strategies and Standards Division  
Office of Air Quality Planning and Standards  
U.S. Environmental Protection Agency  
Research Triangle Park, NC 27711

Paula Hemmer  
E.H. Pechan & Associates, Inc.  
3622 Lyckan Parkway, Suite 2002  
Durham, NC 27707

July, 15 2002

## Contents

2.1	Introduction .....	2-4
2.2	Process Description .....	2-5
2.2.1	Capture Mechanisms .....	2-5
2.2.2	Scrubber Types .....	2-5
2.2.2.1	Spray Tower .....	2-5
2.2.2.2	Cyclonic Spray Tower .....	2-7
2.2.2.3	Dynamic Scrubber .....	2-7
2.2.2.4	Tray Towers .....	2-9
2.2.2.5	Venturi Scrubbers .....	2-9
2.2.2.6	Orifice Scrubber .....	2-10
2.2.2.7	Other Designs .....	2-11
2.3	Configuration and Operation of Venturi Scrubbers .....	2-12
2.3.1	Liquid Storage and Delivery System .....	2-12
2.3.2	Liquid Injection System .....	2-14
2.3.3	Venturi Throat Section .....	2-15
2.3.4	Collection Chamber and Mist Eliminator .....	2-16
2.3.5	Waste Liquid Collection and Disposal .....	2-17
2.3.7	Auxiliary Equipment .....	2-17
2.4	Design Parameters .....	2-18
2.4.1	System Performance .....	2-18
2.4.1.1	Liquid-to-Gas Ratio .....	2-18
2.4.1.2	Velocity and Pressure Drop .....	2-19
2.4.1.3	Particle Size Distribution and Loading .....	2-19
2.4.1.4	Waste Gas Flow Rate, Temperature, and Humidity .....	2-20
2.4.1.5	Residence Time .....	2-21
2.4.1.6	Droplet Size .....	2-22
2.5	System Design .....	2-22
2.5.1	PM Distribution and Loading .....	2-22
2.5.2	Collection Efficiency .....	2-23
2.5.3	Waste Gas Properties .....	2-25
2.5.3.1	Psychrometric Chart .....	2-27

2.5.4	Scrubber Design .....	2-29
2.5.4.1	Estimating Pressure Drop .....	2-30
2.5.4.2	Scrubber Velocity and Cross-Sectional Area .....	2-39
2.5.5	Consumables .....	2-40
2.5.5.1	Water Usage .....	2-40
2.5.5.2	Electrical Power Usage .....	2-42
2.6	Cost Analysis .....	2-43
2.6.1	Total Capital Investment .....	2-43
2.6.1.1	Purchased Equipment Cost .....	2-43
2.6.1.2	Direct and Indirect Installation Costs .....	2-48
2.6.2	Annual Costs .....	2-49
2.6.2.1	Direct Annual Costs .....	2-49
2.6.2.2	Indirect Annual Costs .....	2-50
2.7	Example Problem .....	2-52
2.8	Acknowledgments .....	2-58
References	.....	2-59

## 2.1 Introduction

Particulate matter (PM) is the general term used for a mixture of solid particles and liquid droplets suspended in air. U.S. EPA defines  $PM_{10}$  as particle matter having a nominal aerodynamic diameter of 10 micrometer ( $\mu\text{m}$ ) or less.  $PM_{2.5}$  is defined as PM less than or equal to  $2.5\mu\text{m}$  in aerodynamic diameter. In general, “coarse PM” refers to  $PM_{10}$  while “fine” PM refers to  $PM_{2.5}$ .

A wet scrubber is an air pollution control device that removes PM and acid gases from waste gas streams of stationary point sources. The pollutants are removed primarily through the impaction, diffusion, interception and/or absorption of the pollutant onto droplets of liquid. The liquid containing the pollutant is then collected for disposal. There are numerous types of wet scrubbers which remove both acid gas and PM. This chapter addresses the design and cost of wet scrubbers for control of  $PM_{10}$  and  $PM_{2.5}$ . (See Section 5.2 Chapter 1 for information regarding wet scrubbers for acid gas control.)

Collection efficiencies for wet scrubbers vary with the particle size distribution of the waste gas stream. In general, collection efficiency decreases as the PM size decreases. Collection efficiencies also vary with scrubber type. Collection efficiencies range from greater than 99% for venturi scrubbers to 40-60% (or lower) for simple spray towers [1]. Improvements in wet scrubber designs have increased collection efficiencies in the sub-micron range.

Wet scrubber systems have some advantages over electrostatic precipitators (ESPs) and baghouses. Wet scrubbers are smaller and more compact than baghouses or ESPs. They have lower capital cost and comparable operation and maintenance (O&M) costs. Wet scrubbers are particularly useful in the removal of PM with the following characteristics:

- Sticky and/or hygroscopic materials (materials that readily absorb water);
- Combustible, corrosive and explosive materials;
- Particles which are difficult to remove in their dry form;
- PM in the presence of soluble gases; and
- PM in waste gas streams with high moisture content.

Wet scrubbers have numerous industrial applications including industrial boilers, incinerators, metals processing, chemical production, and asphalt production, and fertilizer production.

The primary disadvantage of wet scrubbers is that increased collection efficiency comes at the cost of increased pressure drop across the control system [2]. Another disadvantage is that they are limited to lower waste gas flow rates and temperatures than ESPs or baghouses. Current wet scrubber designs accommodate air flow rates over 47 actual cubic meters per second ( $\text{m}^3/\text{s}$ ) (100,000 actual cubic feet per minute (acfm)) and temperatures of up to  $400^\circ\text{C}$  ( $750^\circ\text{F}$ ). Another disadvantage is that they generate waste in the form of a sludge which requires treatment and/or

disposal. Lastly, downstream corrosion or plume visibility problems can result unless the added moisture is removed from the gas stream.

## **2.2 Process Description**

This section presents wet scrubber designs used for the control of  $PM_{10}$  and  $PM_{2.5}$  emitted from stationary point sources. Only commonly applied scrubber designs are addressed.

### **2.2.1 Capture Mechanisms**

Particulates contact liquid droplets in wet scrubbers through several mechanisms. Impaction is the primary capture mechanism. When waste gas approaches a water droplet, it flows along streamlines around the droplet. Particles with sufficient inertial force maintain their forward trajectory and impact the droplet. Due to their mass, particles with diameters greater than  $10\ \mu\text{m}$  are generally collected using impaction [3]. Turbulent flow enhances capture by impaction.

Particles dominated by fluid drag forces follow the streamlines of the waste gas. However, particles that pass sufficiently close to a water droplet are captured by interception, capture due to the surface tension of the water droplet. Particles of roughly  $1.0$  to  $0.1\ \mu\text{m}$  in diameter are subject to interception [21]. Increasing the density of droplets in a spray increases interception [1].

Very small-sized particles are subject to Brownian motion, irregular motion caused by random collisions with gas molecules. These particles are captured by the water droplet as they diffuse through the waste gas. Collection due to diffusion is most significant for particles less than  $0.5\ \mu\text{m}$  in diameter [1].

Capture mechanisms that are used less frequently include condensation and electrostatics. In condensation scrubbing, a gas stream is saturated with water vapor and the particle is captured when the water condenses on the particle [3]. In electrostatic scrubbing, contact is enhanced by placing an electrostatic charge on the particle, droplet, or both [2].

### **2.2.2 Scrubber Types**

#### **2.2.2.1 Spray Tower**

The simplest type of scrubber is the spray tower. In a spray tower, particulate-laden air passes into a chamber where it contacts a liquid spray produced by spray nozzles. Towers can be placed in either vertical or horizontal waste gas flow paths. The liquid spray can be directed counter to the gas flow, in the same direction as the gas flow, or perpendicular to the gas flow. Figure 2.1 shows an example of a vertical countercurrent spray chamber. The gas flow enters at the bottom of the tower and flows upward. Water sprays downward from nozzles mounted on the

walls of the tower or mounted on an array at the tower center. Water droplets capture particles suspended in the gas flow through impaction, interception and diffusion. Droplets large enough to settle by gravity collect at the bottom of the chamber. Droplets that remain entrained in the gas stream are collected on a mist eliminator upstream of the nozzles [2]. (Section 2.3.4 discusses mist eliminators in more detail)

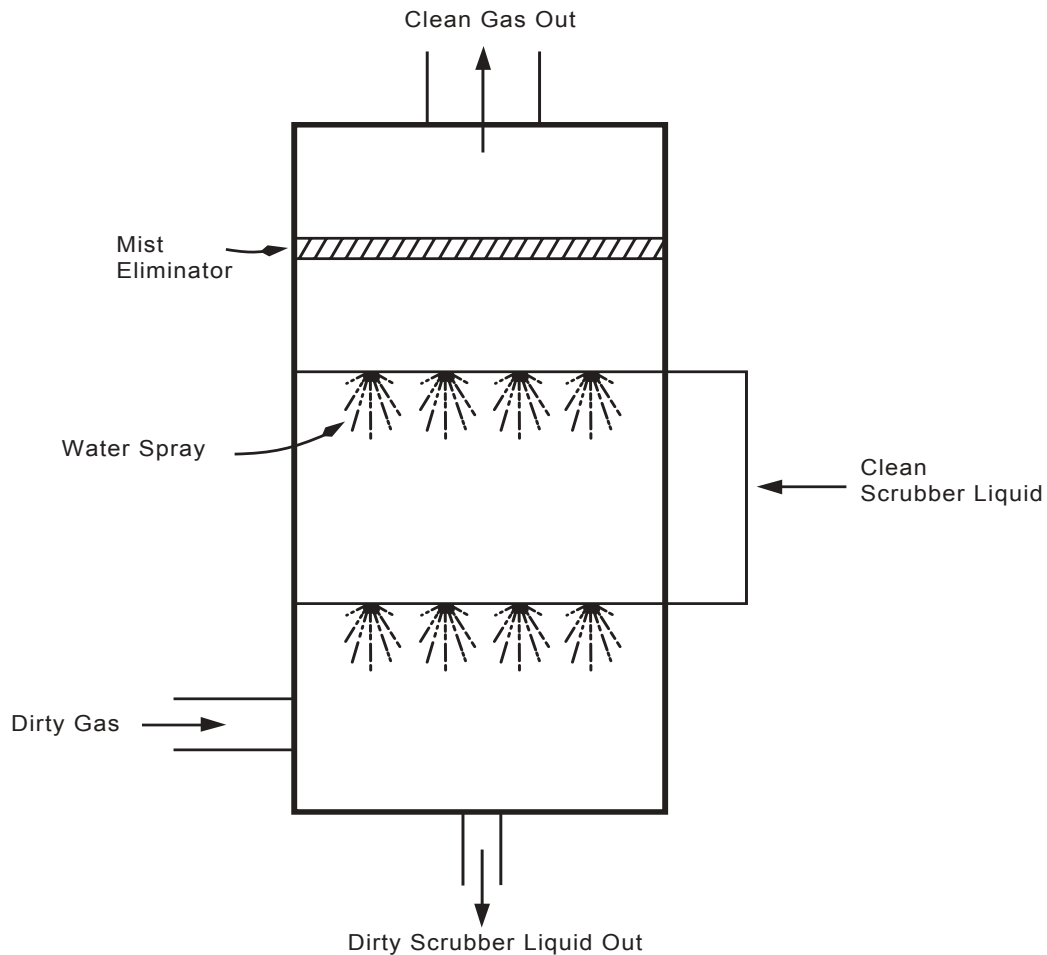

**Figure 2.1:** Spray Tower [4]

Spray towers rely primarily on particle collection by impaction; therefore, they have high collection efficiencies for coarse PM. Typical removal efficiencies for a spray tower can be as great as 90% for particles larger than 5  $\mu\text{m}$ . Removal efficiencies for particles from 3 to 5  $\mu\text{m}$  in diameter range from 60 to 80%. Below 3  $\mu\text{m}$ , removal efficiencies decline to less than 50%. Spray tower applications include control of PM emissions from grinding operations, pigment

operations, and dust control in fertilizer plants. Spray towers can also be applied to control PM from asphalt plant aggregate dryers [1].

Spray towers have lower capital costs than other wet scrubbers. Also, spray towers generally have lower power consumption and are not prone to fouling, so operating costs are also lower [5]. Operating costs of spray towers increase for fine PM applications, because such systems require high liquid to gas ratios (over 20 gallons per 1000 cubic feet (gal/1000 ft<sup>3</sup>)). Typical gas flow rates for spray towers are 1 to 47 standard m<sup>3</sup>/s (1,500 to 100,000 standard cubic feet per minute (scfm)) [6].

#### 2.2.2.2 Cyclonic Spray Tower

Cyclonic spray towers differ from spray tower designs in that the waste gas stream flows through the chamber in a cyclonic motion. The cyclonic motion is produced by positioning the gas inlet tangential to the wall of the scrubbing chamber or by placing turning vanes within the scrubbing chamber. The gas inlet is tapered so that the gas velocity increases as it enters the tower. The scrubbing liquid is sprayed from nozzles in a central pipe (tangential inlet) or from the top of the tower (turning vanes) [1]. Figure 2.2 shows a diagram of a cyclonic spray tower with a tangential inlet [4]. Liquid droplets entrained in the gas stream experience a centrifugal force resulting from the rotating motion of the gas stream, causing them to migrate toward to the tower walls [2]. The droplets impact on the tower walls and fall to the bottom of the tower. Droplets that remain entrained in the waste gas can be removed with a mist eliminator.

Cyclonic spray towers have greater collection efficiencies than simple spray towers due to the greater relative velocity between the droplets and the waste gas in a cyclonic tower. Collection efficiencies for this type of scrubber are as high as 95% for particles greater than 5 μm, and from 60% to 75% for submicron particles. Typical applications are for dust control in fertilizer plants, grinding operations, and foundries [1]. Gas flow rates range from 1 to 47 m<sup>3</sup>/s (1,500 to 100,000 scfm), and power input for a cyclonic scrubber is generally 1 to 3.5 horsepower per 1000 cubic feet per minute (hp/1000 cfm) [2, 6]. Capital costs and operation and maintenance costs are slightly higher for cyclonic spray towers due to their more complex design.

#### 2.2.2.3 Dynamic Scrubber

Dynamic scrubbers are also known as mechanically-aided scrubbers or disintegrator scrubbers. This type of scrubber is similar to spray towers, but with the addition of a power-driven rotor that shears the scrubbing liquid into finely dispersed droplets. The rotor can be located inside the tower or outside the tower, connected by a duct. A mist eliminator or cyclonic separator removes the liquid and captured PM. Most dynamic scrubber systems humidify the waste gas upstream of the rotor to reduce evaporation and particle deposition in the rotar area [1].



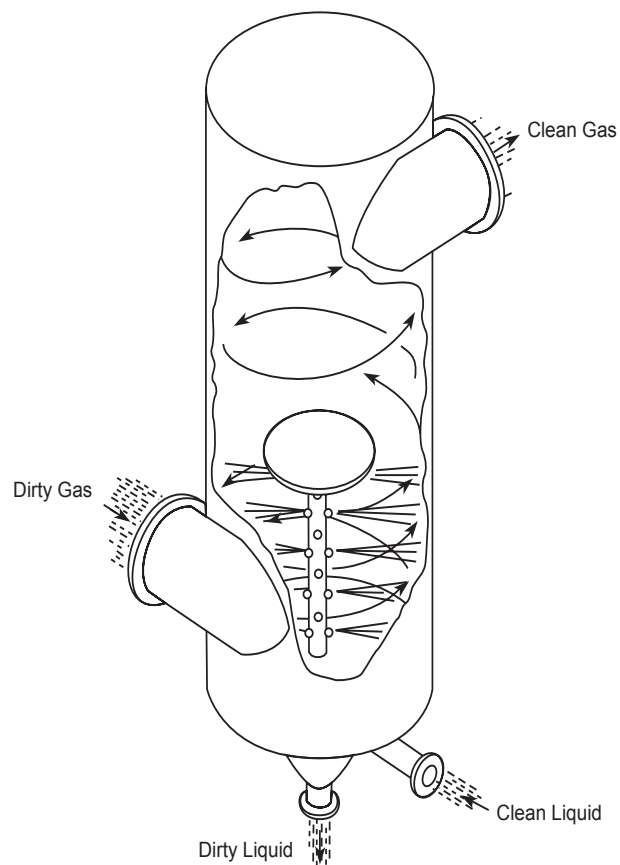

**Figure 2.2:** Cyclonic Spray Scrubber [3]

Dynamic scrubbers efficiently remove fine PM, but the addition of a rotar to the scrubber system increases the maintenance costs. Large PM abrades the rotars and the humid gas stream corrodes them. A pretreatment device, such as a cyclone, often precedes a dynamic scrubber to remove large PM from the waste gas stream [6]. Power consumption is also high for this type of scrubber, between 4 to 10 kilowatts (kW) per 1000 acfm [6, 7]. Dynamic scrubbers generally can treat gas flow rates between 1,000 and 50,000 scfm. Collection efficiencies for dynamic scrubbers are similar to those for cyclonic spray towers [1]. Capital and O&M costs are moderately higher than costs for simple spray towers due to the rotar.

#### 2.2.2.4 Tray Towers

Tray tower scrubbers consist of a vertical tower with several perforated trays mounted horizontally in the tower. Gas enters the tower at the bottom and travels upward through openings in the trays, while the scrubbing liquid flows from the top and across each tray. The gas mixes with the liquid flowing over the tray, providing more gas-liquid contact than in spray tower designs. The gas velocity prevents liquid from flowing down through the perforations in the tray. The impingement plates are continuously washed clean of collected particles by the flowing liquid. Tray towers are designed to provide access to each tray for cleaning and maintenance [6]. Large PM can clog the perforations, therefore, some designs place impingement baffles upstream of each perforation to remove large PM prior to the waste gas entering the opening [6]. This type of tray tower is referred to as an impingement-plate or impactor scrubber.

Tray towers do not effectively remove submicron particles, however, collection efficiencies of 97% are possible for particles larger than 5  $\mu\text{m}$  [5]. Tray towers also effectively remove soluble gases; therefore they are useful when both particulate and gaseous pollutants must be removed. Typical applications include lime kilns, bagasse and bark boilers, and secondary metals industries [1, 6]. Gas flow rates for tray tower designs are generally between 1,000 to 75,000 scfm. Liquid to gas ratios are low compared to spray towers and venturi scrubbers because the scrubbing liquid is essentially static [1]. Capital and O&M costs of tray and impingement towers are moderately higher than simple spray towers.

#### 2.2.2.5 Venturi Scrubbers

A venturi scrubber has a “converging-diverging” flow channel. In this type of system the cross-sectional area of the channel decreases then increases along the length of the channel. Figure 2.3 presents a venturi scrubber. The narrowest area is referred to as the “throat”. In the converging section, the decrease in area causes the waste gas velocity and turbulence to increase. The scrubbing liquid is injected into the scrubber slightly upstream of the throat or directly into the throat section. The scrubbing liquid is atomized by the turbulence in the throat, improving gas-liquid contact. The gas-liquid mixture then decelerates as it moves through the diverging section, causing additional particle-droplet impacts and agglomeration of the droplets. The liquid droplets are then separated from the gas stream in an entrainment section, usually consisting of a cyclonic separator and mist eliminator [3]. Design, operation and cost of venturi scrubbers are the focus of this chapter and are discussed in greater detail in Section 2.3.

Venturi scrubbers are more expensive than spray tower, cyclonic, or tray tower scrubbers, but collection efficiencies for fine PM are higher. High gas velocities and turbulence in the venturi throat result in high collection efficiencies, ranging from 70% to 99% for particles larger than 1  $\mu\text{m}$  in diameter and greater than 50% for submicron particles [1,6]. Increasing the pressure drop in a venturi scrubber increases the efficiency, but the system’s energy demand also increases leading to greater operational costs. Capital and O&M costs are moderately higher than costs for simple spray towers.

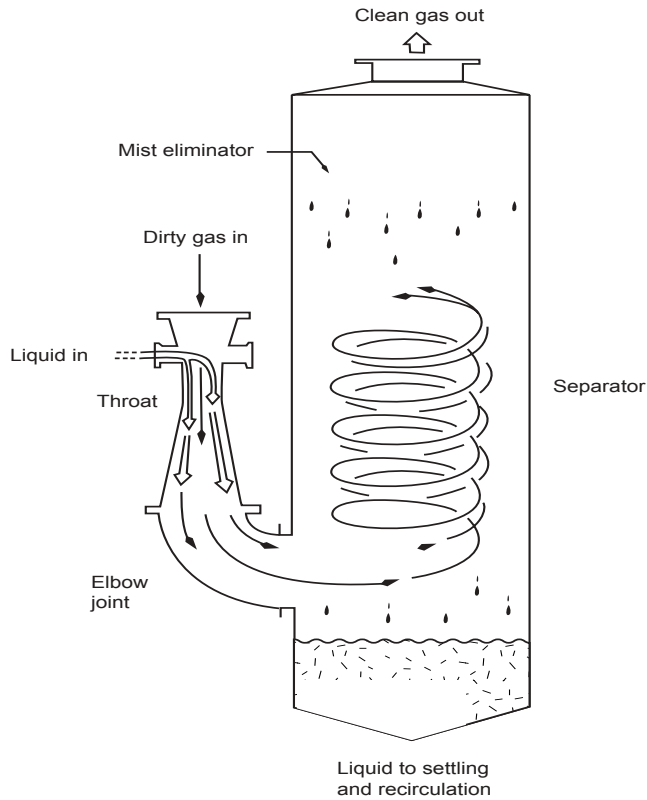

**Figure 2.3:** Venturi Scrubber with Cyclone Separator and Mist Eliminator [3]

#### 2.2.2.6 Orifice Scrubber

In an orifice scrubber, also referred to as an impaction scrubber, the gas stream flows over the surface of a pool of scrubbing liquid. As the gas impinges on the water surface, it entrains droplets of the liquid. The waste gas then flows upward and enters an orifice with a narrower opening than the duct. The orifice induces turbulence in the flow which atomizes the entrained droplets. The atomized droplets capture the PM in the gas stream. A series of baffles then removes the droplets, which fall into the liquid pool below. Some orifice scrubbers have adjustable orifices to control the gas velocity. Orifice scrubbers accommodate gas flow rates up to 50,000 scfm and particle loadings up to  $23 \text{ g/m}^3$  (10 grains per scf). The primary advantage of this type of scrubber is the elimination of a recirculation pump for the scrubbing liquid, which is a major contributor to operating costs for most scrubber designs [6]. The primary disadvantage is the difficulty of removing waste sludge. In most scrubber designs, waste continually drains from the bottom. Orifice scrubbers employ a static pool of scrubbing liquid, so waste sludge is removed with a sludge ejector, which operates like a conveyor belt. The sludge settles onto the ejector, which conveys it out of the scrubber [8].

Orifice scrubbers are not widely used, but have been applied to dryers, cookers, crushing and grinding operations, spray operations (pill coating, ceramic glazing), ventilation (bin vents, dumping operations), and material handling (transfer stations, mixing, dumping, packaging). This type of scrubber can effectively remove PM over 2  $\mu\text{m}$  in diameter, with control efficiencies ranging from 80-99%. Though orifice scrubbers can be designed as high-energy units, most are built for low-energy service. Capital and O&M costs are significantly higher than costs for simple spray towers.

#### 2.2.2.7 Other Designs

Packed tower scrubbers are towers containing a bed of packing material. The packing material provides a large wetted surface for gas-liquid contact. Scrubbing liquid is introduced at the top of the tower and flows down through the packing, coating the packing and forming a thin film. Packing materials are available in a variety of forms, each having specific characteristics with respect to surface area, pressure drop, weight, corrosion resistance, and cost. Packed towers are most often used for gas adsorption rather than PM removal, because high particle concentrations can build up on the packing and clog the tower [6]. Packed-bed scrubbers are discussed in detail in Section 5.2, Chapter 1 of the Manual, “Wet Scrubbers for Acid Gas Control”.

In a condensation scrubber, the particles act as condensation nuclei for the formation of water droplets. First, the gas stream is saturated with water vapor. Steam may also be injected to further increase the humidity ratio. The injection of water vapor and/or steam creates a condition of super-saturation leading to the condensation of water on particles in the gas stream. The droplets are then removed by a conventional device, such as a mist eliminator. Condensation scrubbers can effectively remove fine PM and have collection efficiencies of greater than 99%. However, the scrubber can only remove relatively small amounts of dust due to the amount of saturation and condensation that are capable of being maintained in the gas stream. Condensation scrubbers are generally intended to be used downstream of another scrubber that has already removed particles larger than 1  $\mu\text{m}$  in diameter. Condensation scrubbing is a relatively new technology and has limited commercial availability [6]. Its most frequent application is to hazardous waste or medical waste incinerators.

Charged scrubbers enhance removal by placing an electrostatic charge on the water droplets, particles, or both prior to entering the scrubber. These scrubbers usually employ a conventional scrubber design, such as a spray tower. The particulates can be negatively or positively charged, with droplets given the opposite charge. Wet ESPs are similar devices which combine an ESP with flowing liquid to continuously clean electrostatic plates [1].

Commercially available wet scrubbers employ a wide range of design variations, including several hybrids of technologies. For example, a few manufacturers offer venturi scrubbers with multiple throats. Other manufacturers combine wet scrubber devices with other types of particulate removal, such as a baghouse or ESP.

## 2.3 Configuration and Operation of Venturi Scrubbers

There are three basic types of venturi scrubbers. The primary difference between the configurations is the energy required for scrubbing the waste gas and moving it through the unit. In a conventional venturi, an external device, typically an induced draft (ID) fan, transfers energy to the liquid-gas stream. The fan can be located either upstream or downstream of the venturi unit. The basic venturi scrubber design is very efficient at removing  $PM_{10}$  from both a cost and performance perspective. In a “jet” or “eductor” venturi, pressurized scrubbing liquid is injected into the throat. This type of venturi operates at low pressure drops, generally a few inches of water column. A jet venturi has a lower collection efficiency for fine PM than a conventional venturi. A “high energy” venturi provides increased collection efficiency for fine and submicron PM. A high energy system utilizes a large ID fan to create a high gas side pressure drop, 30 inches of water column or greater. This greatly increases the waste gas velocity prior to entering the throat and results in high collection efficiency. However, capital costs and electrical power requirements for high energy systems are much higher than a conventional venturi.

Venturi systems can be installed on either horizontal or vertical waste gas flow paths. They can be purchased as packaged, skid mounted units or as field erected units. Materials of construction for system components include carbon steel, stainless steel, duplex alloys, FRP or lined steel. The waste gas properties determine which material is most appropriate for a given application. More than one type of material can be incorporated into a venturi system if necessary.

Figure 2.4 presents the schematic of a venturi system. The basic system components of a venturi scrubber are:

- liquid storage system and delivery system;
- liquid injection system;
- venturi throat section;
- collection chamber with a mist eliminator;
- waste liquid collection system and disposal;
- instrumentation and controls; and
- auxiliary equipment.

Each of these components are discussed in the following sections.

### 2.3.1 Liquid Storage and Delivery System

The liquid storage and delivery system consists of a recirculation tank, pump, filters, valves, piping, pressure gauges, and flow meters. Most systems are designed as recycle systems, meaning the spent scrubbing liquid is recirculated through the scrubber system. Since the scrubbing liquid is recycled, the solids content of the liquid increases as PM is collected. The concentration of solids in a recycle system must be maintained below a design limit or the spray characteristics of the system cannot be maintained. To reduce the solids concentration, a

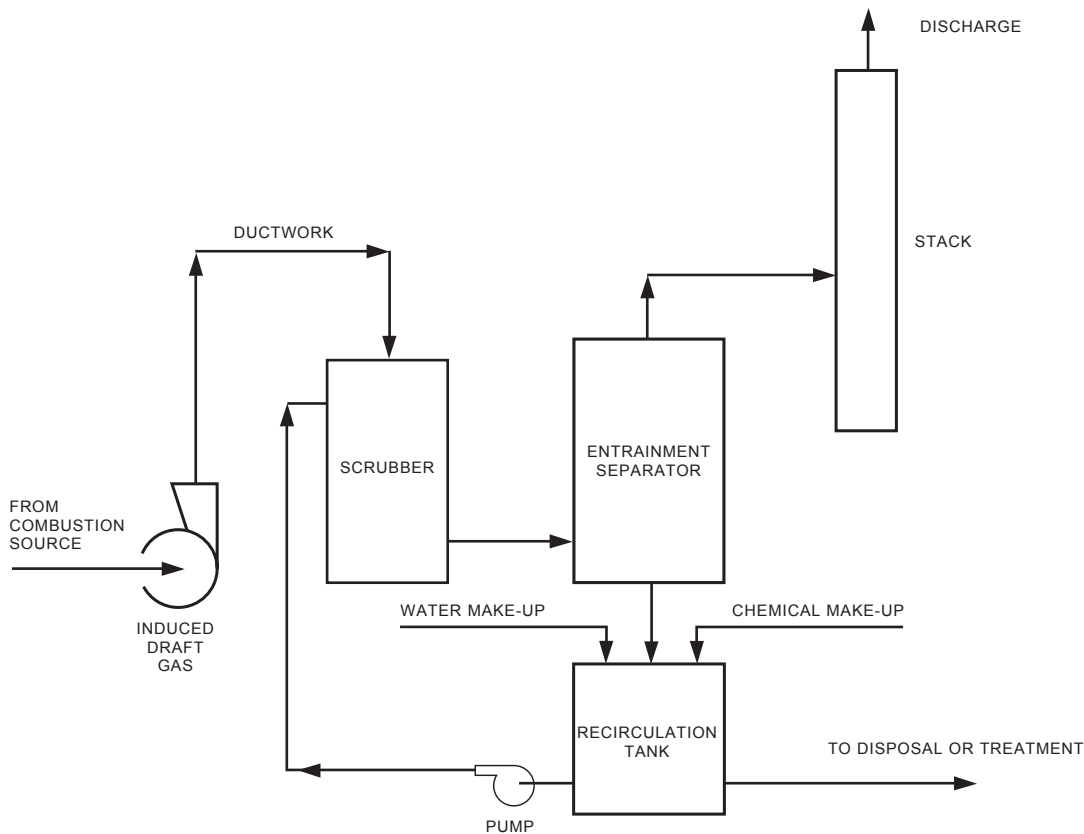

**Figure 2.4:** Schematic of Venturi Scrubber System

portion of the liquid is bled from the system and fresh scrubbing liquid is added. The volume of “make up” liquid also includes the volume of water that is lost due to evaporation by hot waste gas.

The tank must be sized to provide continuous operation and minimize frequent changing of the liquid. A sensor in the tank monitors the level of liquid. An automated system for adding liquid can be incorporated into the scrubber design. However, oversizing the tank and automating the addition of make up water increases the capital cost and complexity of the system. The increase in capital cost must be weighed with the O&M cost for operating the liquid storage and delivery system manually.

Solids can be removed from the scrubbing liquid using several different methods. In one method, the scrubbing liquid is gravity fed to a set of filters located upstream of the pump to remove solids. The filter is generally constructed out of stainless steel and is removable for cleaning and replacement. A backup filter and set of isolation valves are often included in the system to

facilitate cleaning of the filters while operating the system. Other solids removal methods include liquid cyclones or settling tanks.

After leaving the tank, the scrubbing liquid flows to a pump to increase the pressure and flow rate to the values required for proper operation of the venturi system. Pressure gauges and flow meters downstream of the pump monitor the scrubbing liquid flow and pump operation. A feedback control system can be added to the system to automate control of the pump.

### **2.3.2 Liquid Injection System**

The injection system design promotes mixing of the waste gas and scrubbing liquid in the venturi. There are two basic systems for injecting scrubbing liquid into a venturi system: open pipe (also referred to as “wet approach”) and spray nozzles. The injection systems are generally located in the waste gas duct, directly upstream of the venturi throat section. In both systems, the liquid is injected in the same direction as the waste gas stream. Most injection systems are constructed out of stainless steel or other non-corrosive material.

In an open pipe system, several small diameter pipes feed the scrubbing liquid into the duct section. The pipes inject the liquid tangentially, along the duct walls or radially against baffle plates. The water flows downward, covering the walls of the duct. The piping system is designed so that the entire surface area of the section is flooded with the scrubbing liquid. This ensures that there is no dry/wet transitional zone. Dry/wet areas lead to a build up of solids on the duct wall that interferes with the operation of the scrubber. The dust laden gas enters the scrubber vertically from the top and immediately hits the film of scrubbing water. Some separation of the PM from the waste gas takes place in this area. In the throat section, the waste gas stream becomes very turbulent and the scrubbing liquid is sheared to form a dispersion of droplets. Open pipe systems have lower capital and O&M costs than spray nozzles due to their simpler design.

Spray nozzles systems are sometimes referred to as “jet venturis” or “eductor venturis”. These systems inject liquid through nozzles to create a fine droplet spray pattern. The droplets can be produced either pneumatically or hydraulically using specially designed nozzle heads. While spray nozzles improve mixing between the scrubbing liquid and the waste gas, they generally have higher capital and operating costs than open pipe systems due to the higher pump horsepower required for this type of system.

In jet venturis, the nozzles can be attached to the wall of the duct or can be located in the duct cross section. For throat areas greater than 1 foot in width, a spray nozzle must be located in the center of the duct to ensure adequate liquid-PM contact [1]. Nozzles can be constructed out of stainless steel or more specialized materials such as stellite and ceramic [9]. Because nozzles are prone to plugging and abrasion in high PM load conditions, this type of system requires clean liquid feed to avoid clogging [6]. High temperatures and gas velocities can damage the nozzles, consequently, they should be designed to be removable for cleaning and replacement. See Hueman for examples of nozzles and spray patterns [10].

### 2.3.3 Venturi Throat Section

The throat consists of the narrowest portion of the converging-diverging venturi section. This is where the velocity and turbulence of the waste gas is greatest. In the throat, the waste gas shears the scrubbing liquid into a high density distribution of fine droplets. These droplets collect PM primarily through impaction. The waste gas and scrubbing liquid then pass into the diverging section where the velocity decreases, causing more impaction and liquid agglomeration. Some of the energy imparted to the liquid-gas system is recovered in the diverging section as gas pressure. However, the overall energy of the system decreases due to friction and other mechanical losses. This loss is measured as the decrease in pressure across the venturi converging-diverging section, referred to as the pressure drop,  $\Delta P$ .

There are a number of different throat configurations that are commercially available, including fixed throat, variable throat, variable annual throat multiple throat, and multiple stage. Figure 2.5 presents schematics of a fixed throat, a variable throat with a damper, an annual variable throat, and a multiple throat.

A fixed throat venturi is the simplest type of venturi. The throat section can be circular or rectangular, depending on the duct shape of the current waste gas system. Rectangular throats are generally limited to a width of approximately 10 in. due to mixing considerations. Circular fixed throats are typically used in high-pressure applications. [1]

A variable throat venturi changes the cross-sectional area of the throat through the use of an adjustable damper. There are many different damper designs including conical plugs, discs, and blades. The venturi throat area is increased or decreased by the dampers when the waste gas inlet conditions change. This allows the venturi to maintain the same throat velocity and, therefore, the same collection efficiency even with fluctuations in the waste gas flow conditions. A control system can be incorporated into the variable throat device to automatically adjust to changes in the gas flow. Automatic throat adjustment is typically used where flow conditions vary widely and frequent adjustments are required. The complexity of a variable throat increases the capital and O&M costs of the venturi.

A multiple throat venturi is a set of parallel venturis in one duct section. The throats are created by fixed length rods or flat plates located across the cross-section of the duct. The number of throats and width of the throats vary between designs. Most systems have throats on the order of 1 to 2 inches in width [1]. The throats can be designed as fixed or variable. This type of design not only decreases the throat area but increases the wetted area of the venturi, resulting in higher collection efficiency. Multiple throat venturi systems work efficiently in low pressure applications.



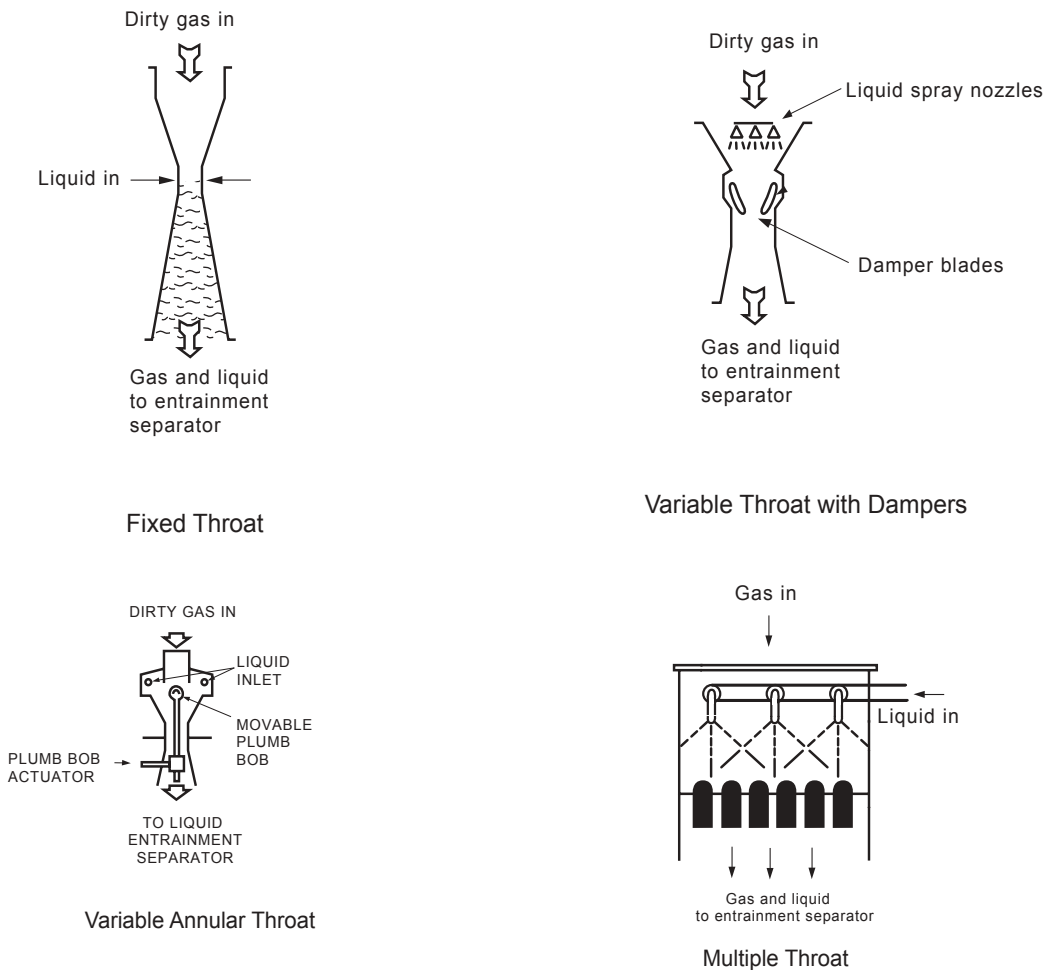

**Figure 2.5:** Venturi Throat Configurations [9, 11]

A multiple stage venturi is simply a series of venturi scrubbers. This type of scrubber system can have two basic forms. The first type is a set of venturi throats in series which share a common collection chamber and liquid injection system. The throats are comprised of sets of vanes or baffles within a duct section. The second type of multiple stage venturi places a set of stand-alone venturi scrubber systems in series, each with its own collection chamber and liquid injection system.

### 2.3.4 Collection Chamber and Mist Eliminator

After passing through the venturi section, the scrubbing liquid and waste gas enter a collection chamber that separates the entrained liquid-PM droplets from the waste gas. A portion of the droplets settle via gravity to the bottom of the chamber. The droplets which remain entrained in the

waste gas are generally removed with a mist eliminator. An outlet is located at the bottom of the collection chamber to drain the liquid-PM waste from the chamber. The collection chamber can be a simple tower design, a tower with interior baffles, or a cyclone. Baffle and cyclone designs enhance the removal of liquid and PM from the waste gas stream using impaction as well as gravity. However, they result in larger waste gas pressure drops and cost more than a simple tower.

Mist eliminators remove between 90% and 99% of the liquid droplets from the waste gas stream [1]. There are two basic designs, chevron and mesh pad mist eliminators. The droplets collect and coalesce on the chevron blades or mesh. When the droplets become large enough, they fall by gravity or capillary action. Mesh pad mist eliminators can be clogged by the particulate, therefore, chevron designs are more frequently applied. Pressure drop across a mist eliminator is low, 0.5 to 1.0 inches of water column (in w.c.) All mist eliminators require periodic washing to remove buildup of PM [1].

In many venturi systems, the direction of flow through the venturi section is downward. After passing through the venturi, the flow turns horizontal prior to entering the collection chamber. Turning the high velocity flow results in a decrease of the waste gas pressure and abrasion of the elbow joint due to friction. To minimize these effects, many venturi designs utilize a “flooded elbow”, an elbow duct with a pool of water or scrubbing liquid at the bottom. The liquid in the elbow duct decreases friction and collects heavy droplets in the waste gas stream.

### **2.3.5 Waste Liquid Collection and Disposal**

Spent scrubber liquid drains from the bottom of the chamber to the recirculation tank. A portion of the liquid is bled from the system to limit the solids concentration to 20% to 30% by weight [12]. The effluent is in the form of a slurry with high solids content and, in some applications, may contain hazardous material. Nonhazardous effluent can be treated in an existing wastewater system or by an off-site contractor. The liquid is separated from the solid waste, then the wastewater is reused or discharged. The remaining solid or sludge is landfilled if non-toxic and inert. Waste gas containing hazardous PM requires treatment and/or hazardous waste disposal of the sludge. The annual cost for hazardous waste disposal is a direct function of the wastewater flow rate, suspended solids content, and the hazardous nature of the waste (i.e. flammable, toxic, corrosive, etc.). Disposal costs include the cost of laboratory analysis, transportation costs, and the cost of treatment, destruction, landfill, or other disposal method. Due to the high variability of disposal costs, these costs are not included as part of annual costs in Section 2.6.2.

### **2.3.7 Auxiliary Equipment**

An ID fan is generally required to make up for pressure lost in a low energy venturi system. Fans marginally increase the capital cost of the venturi system but greatly increase O&M costs due to the electrical power usage and maintenance requirements of the fan. Power input for the fan ranges from 3 to 12 hp/1000 cfm [2]. The ID fan can be placed either upstream or downstream

of the venturi wet scrubber. The fan placement is dependant on the waste gas characteristics. For instance, applications with high particulate loading place the fan downstream to avoid pitting of the fan blades. To reduce corrosion and pitting, the fan can be manufactured out of stainless steel or coated with special materials.

High temperature gas streams evaporate large amounts of scrubbing liquid, causing a decrease in the number of droplets generated by the venturi. Therefore, high temperature applications must either cool the gas before entering the venturi, or spray a greater volume of water into the venturi. The gas can be cooled with a quencher, which sprays water into the gas stream. When the water evaporates, the temperature of the gas stream decreases. Quenchers marginally increase the capital and operating costs of the system.

Venturi systems may require additional equipment to a fan and quencher. A PM collection system such as a hood may be required to collect the waste gas from the source. An upstream PM collection device such as a cyclone may be required to remove large PM and prevent abrasion of the venturi components. A stack may be required after the venturi to release the waste gas into the atmosphere at the a specified height. Lastly, a reheating device may be required to increase plume buoyancy (height) for better dispersion and to decreases plume visibility caused by condensing water.

## **2.4 Design Parameters**

### **2.4.1 System Performance**

The parameters affecting the overall performance of a wet scrubber are:

- Particle size distribution and loading;
- Waste gas flow rate, temperature and humidity;
- Gas velocity and pressure drop;
- Liquid-to-gas (L/G) ratio;
- Droplet size; and
- Residence time.

Each of these parameters are briefly discussed below.

#### **2.4.1.1 Liquid-to-Gas Ratio**

The liquid-to-gas ratio (L/G) is the volume of liquid injected per volume of waste gas treated. In general, a higher L/G ratio increases collection efficiency since the density of droplets across a given cross-section of the venturi is higher. Liquid flow rates between 7 and 10 gal/1000 ft<sup>3</sup> give optimum performance. L/G ratios in this range produce fairly constant collection efficiencies given a constant pressure drop [13]. L/G ratios of greater than 10 gal/1000 ft<sup>3</sup> do not improve the

scrubber performance significantly. While increasing the L/G ratio increases collection efficiency, operating costs are increased as well due to greater scrubbing liquid and pump usage.

#### 2.4.1.2 Velocity and Pressure Drop

Increasing the relative velocity between the gas and the liquid droplets increases the momentum of the particulate, allowing smaller particles to be collected by impaction. The relative velocity can be increased by narrowing the throat, injecting the scrubbing liquid counter-current to the flow, or spraying the liquid into the throat. However, increasing relative velocity generally increases the pressure drop, energy demand, and operating costs for the scrubber [5]. High energy venturis increase the gas velocity using an induced draft fan upstream of the venturi. These systems have much higher operating costs than low energy venturis due to the higher fan power.

The smaller the cross-sectional area of the throat, the greater the increase in the gas velocity obtained. The highest gas velocity occurs at the center point of the narrowest cross-section, generally ranging from 45 to 150 meters per second (m/s) (150 to 500 feet per second (ft/s)). The resulting pressure loss of the gas stream across the venturi is in the range of 10 to 80 in w.c. In general, increasing the pressure drop above 45 in w.c. does not significantly increase the removal efficiency for conventional venturi designs [1]. Venturi designs optimize the cross sectional area of the throat to provide high gas velocities while minimizing pressure drop. In addition, the diverging section of the venturi is designed to recover the most pressure. Diverging sections are designed to decrease the waste gas velocity to between 30 and 15 m/s (100 and 50 f/s) [13, 24]. At this speed, turbulent losses are minimized and the greatest amount of energy recovery is achieved.

#### 2.4.1.3 Particle Size Distribution and Loading

The performance of a given scrubber type is highly dependant on the size distribution of the PM in the waste gas stream. The size distribution determines the capture mechanism, impaction, interception or diffusion, that dominates. Most wet scrubber designs rely almost exclusively on inertial impaction for particulate collection. Particles smaller than 0.1  $\mu\text{m}$  are captured primarily through diffusion mechanisms [5]. Figure 2.6 presents the approximate collection efficiency of a venturi wet scrubber as a function of particle size. Note that the efficiency decreases exponentially with particle size.

PM loading, also called dust loading, is the mass of PM per unit volume in the waste gas at the inlet of the scrubber. As PM loading increases, the L/G ratio must increase to maintain the same collection efficiency. Figure 2.7 presents the L/G as a function of particulate loading. Higher PM loading also results in higher solids content of the recycled scrubbing liquid. In order to maintain the solids content, a greater volume of scrubbing liquid must be bled from the system as waste and a greater volume of clean scrubbing liquid must be added to the system. Higher PM loadings increase the operating costs of the system due to increased pump usage, scrubbing liquid usage, and waste liquid disposal. Applications with high PM loadings also require more maintenance, as particles can cause plugging of orifices and wear to parts such as nozzles and fans.

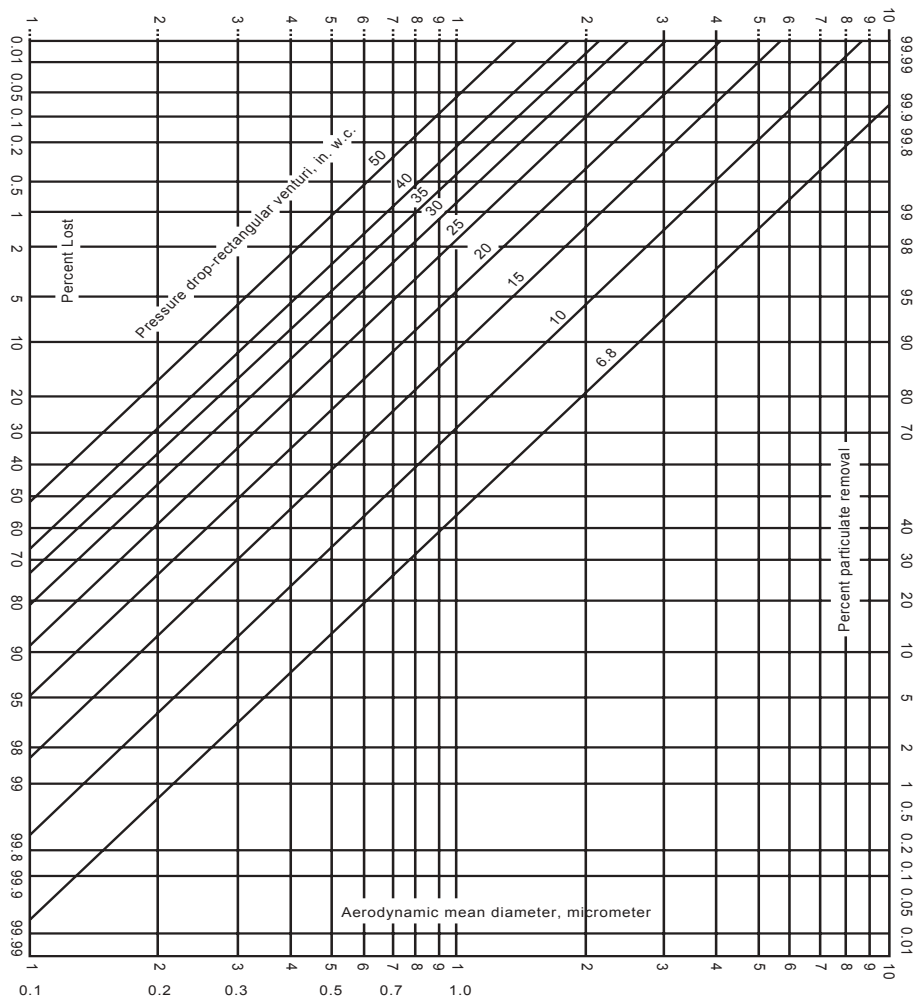

**Figure 2.6:** Approximate Collection Efficiencies of Particles in the 0.1-10  $\mu\text{m}$  Diameter Range at Venturi Pressure Drops in the 6.8-50 in.  $\text{H}_2\text{O}$  Range [2]

#### 2.4.1.4 Waste Gas Flow Rate, Temperature, and Humidity

The waste gas flow rate is the most important sizing parameter in a wet scrubber. The higher the waste gas flow rate, the larger the venturi system and volume of scrubbing liquid required to treat the waste gas. Wet scrubbers operate at lower gas flow rates than baghouses or ESPs because of the liquid injection. New low energy venturis can accommodate air flow rates of up to 95 m/s (300,000 acfm). Jet venturi systems are generally limited to approximately 3 m/s (10,000 acfm) and multi-throat and high energy venturi systems are limited to approximately 47 m<sup>3</sup>/s (150,000 acfm).

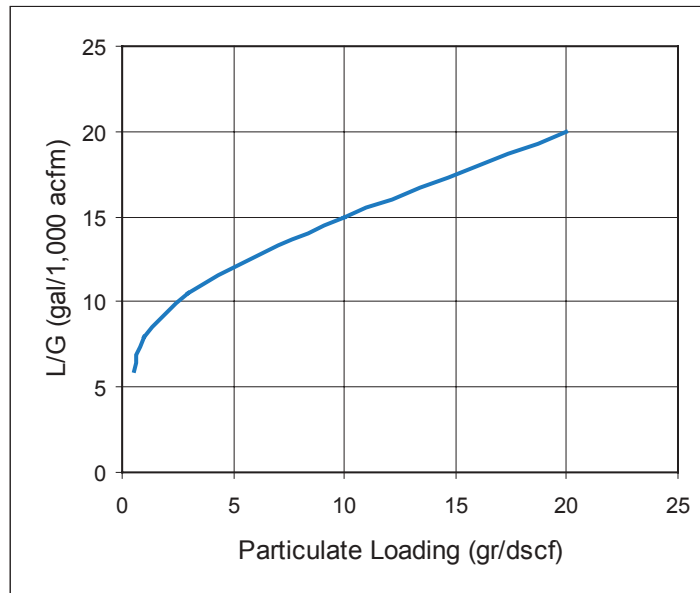

**Figure 2.7:** Liquid to Gas Ratio as a Function of Particle Loading [16] [22]

The waste gas temperature and humidity also impacts the venturi design. When air passes through a wet scrubber, water evaporates, which increases humidity and cools the gas stream. The amount of evaporation is determined by the inlet temperature and humidity. High evaporation rates will increase the L/G ratio required by the system. For PM applications, wet scrubbers are generally limited to a temperature range of (50°F to 700°F) due to evaporation. A quencher may be needed for higher temperature applications. High temperature affects the material used to manufacture the scrubber components.

#### 2.4.1.5 Residence Time

Increasing the length of the throat and the diverging section, increases the contact time between the liquid and the PM suspended in the waste gas. For example, a venturi with a throat length of 1 foot and a velocity of approximately 450 ft/sec has a contact time of 1/450 of a second. This is minimal time for mixing and contact between the liquid and waste gas. For a cylindrical throat, a throat length to throat diameter ratio of 3:1 is the minimum recommended [13]. For high energy systems, it is recommended that the length of the diverging section of the throat to be at least 4 times the width of the throat in order to have sufficient contact time. [1]

#### 2.4.1.6 Droplet Size

There is an optimum droplet size for maximizing collection of PM. Smaller droplets have a larger surface area to volume ratio, therefore, they capture more particles per volume of liquid injected. However, if the droplet size becomes too small, the momentum of the waste gas can be imparted to the droplets which decreases the relative velocity between the droplet and particles. Lower relative velocity results in lower collection efficiency. Wet scrubbers control the size of droplets using several techniques. In scrubbers using preformed droplets, such as spray towers, the droplet size is determined by the type of nozzle and the system operating conditions. In dynamic scrubbers, the speed of the rotor and L/G controls the droplet size. In venturi scrubbers, the droplet size is controlled by the L/G and the gas velocity in the throat.

## 2.5 System Design

### 2.5.1 PM Distribution and Loading

The design and performance of a given scrubber type is highly dependant on the properties of the particulate matter in the waste gas stream. As discussed in section 2.4, the most critical properties are particle size distribution and PM loading. There is a wide distribution of both particle sizes and loading across industrial sources. Source-specific PM distribution and loading determine the most efficient PM collection device on a case-by-case basis.

Because particles have various shapes and densities, particle size is usually expressed as the aerodynamic diameter. The aerodynamic diameter of a particle is the diameter of a sphere with the density of water that settles in still air at the same rate as the particle in question. The size distribution is usually measured using a cascade impactor, which separates particles by their aerodynamic diameter onto plates. The mass of particles on each impaction plate is measured [5]. Figure 2.8 presents a typical PM particle size distribution, the cumulative mass verses the particle size. Notice it is a log-normal distribution. PM from industrial sources, generally have a log-normal distribution.

The geometric mean diameter is the aerodynamic diameter of the 50<sup>th</sup> percentile of PM on a mass basis (also referred to as mass median particle diameter). By definition, the standard deviation of a log-normal distribution is the ratio of the 84<sup>th</sup> percentile to 50<sup>th</sup> percentile particle sizes on a mass basis:

$$\sigma = \frac{d_{84}}{d_{50}} \quad (2.1)$$

where  $\sigma$  = standard deviation,  
 $d_{50}$  = mass fraction of the 50<sup>th</sup> percentile particle size, and  
 $d_{84}$  = mass fraction of the 84<sup>th</sup> percentile particle size

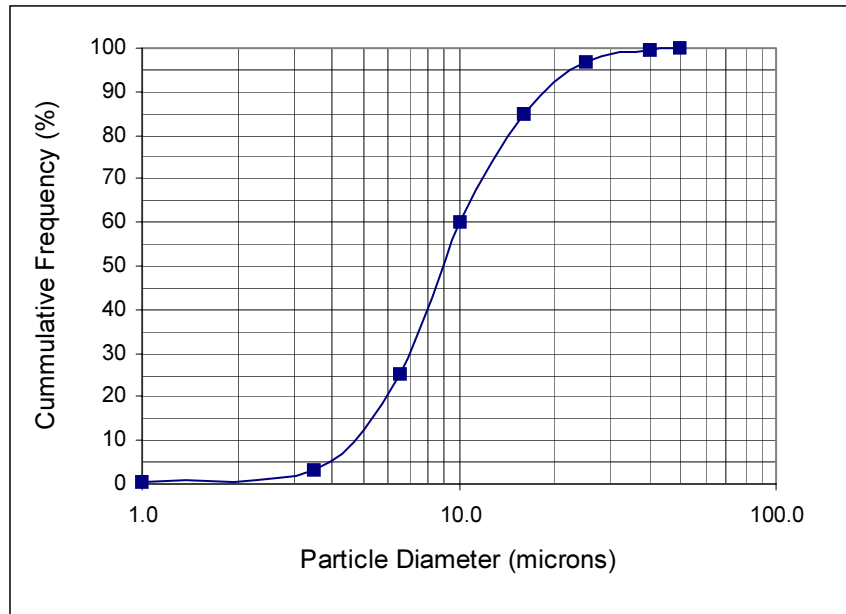

**Figure 2.8:** Particle Size Distribution for a PM Source

### 2.5.2 Collection Efficiency

Collection efficiency is the amount of PM removed from the gas stream by the wet scrubber. This efficiency can be expressed a number of ways including the efficiency of a single water droplet, the efficiency of the scrubber on a mass basis, or the efficiency of the scrubber on a particle size basis. Each of these efficiencies is defined below.

The collection efficiency of a single droplet  $\eta_{drop}$  is defined as the area swept free of aerosol particles divided by the projected cross-sectional area of the droplet.

$$\eta_{drop} = \frac{\text{area swept free of particles}}{\text{droplet cross - sectional area}} \quad (2.2)$$

The overall efficiency of the scrubber is usually related to  $\eta_{drop}$  by an empirical exponential equation. However, most of the parameters in the equation are generally not available at the study level. Therefore, this chapter does not present this method of determining efficiency.



Collection efficiency on a mass basis is given by:

$$\eta_m = \frac{\dot{m}_i - \dot{m}_o}{\dot{m}_i} = \frac{l_i - l_o}{l_i} \quad (2.3)$$

where  $\eta_m$  = overall collection efficiency on a mass basis,  
 $\dot{m}_{i,o}$  = total mass flow rate at inlet, outlet, and  
 $l_{i,o}$  = particle loading at inlet, outlet.

Collection efficiency as a function of particle size distribution is the cumulative collection efficiency for each particle size range given by:

$$\eta_d = \sum_0^j \eta_j m_j \quad (2.4)$$

where  $\eta_d$  = overall collection efficiency,  
 $\eta_j$  = fractional efficiency for jth particle diameter range,  
 $m_j$  = mass fraction of jth particle diameter range, and  
 $j$  = number of particle diameter ranges.

The mass fraction is defined by:

$$m_j = \frac{\text{mass of particles in range of interest}}{\text{total mass}}$$

Collection efficiency on a mass basis is generally higher than the collection efficiency on a particle basis. This is because the larger size particles, which are generally more massive, tend to be collected at higher efficiencies than smaller diameter particles. Therefore, it is more common to express efficiency on a particle size basis than a mass basis.

Penetration is defined as the fraction of particles that pass through the collection device. Penetration is directly related to collection efficiency by:

$$Pt_d = 1 - \eta_d \quad (2.5)$$

where  $Pt_d$  = overall penetration of collection device,  
 $\eta_d$  = overall efficiency on a particle size basis.

Design equations for PM removal devices often utilize the cut diameter, the diameter at which the collection efficiency of the scrubber is 50%. Cut diameter is a characteristic of the control device and operating conditions, not the particle size range. It is determined experimentally using the particle collection efficiency and particles size distribution data collected for a given device and set of operating conditions.

### 2.5.3 Waste Gas Properties

The physical and chemical properties of the waste gas are generally given to the vendor to properly size the scrubber system and choose appropriate materials for fabrication. These properties have a direct impact on capital and annual costs associated with the scrubber as well as impacting design. The designer needs information on conditions at both the inlet and outlet including:

$Q$	=	volumetric flow rate;
$V$	=	volume;
$T$	=	temperature;
$P$	=	pressure; and
$\theta_{H_2O}$	=	fractional moisture content.

Waste gas properties are measured at the scrubber inlet to the scrubber. Outlet waste gas properties change as a function of the evaporation rate of the scrubbing liquid. This discussion uses the following subscripts:

$m$	=	dry air and water vapor mixture;
$a$	=	dry air;
$wv$	=	water vapor;

As hot flue gas passes through the scrubber, a portion of the water in the scrubbing liquid evaporates. The temperature of the flue gas decreases, the moisture content and humidity increases, and the volume decreases. For design purposes, the conditions of the waste gas at the scrubber outlet are assumed to be at the saturation point.

Evaporation through the scrubber is generally modeled as a direct evaporative cooling process (also referred to as an adiabatic saturation process). In this process, the non-saturated (dry) air is cooled by transferring the air's sensible heat to the water vapor as latent heat. The total quantity of heat energy contained in the air, the enthalpy, remains constant. In addition, the system is assumed to conserve mass and the waste gas is assumed to behave as an ideal gas. Under these assumptions, the mass flow rate of dry air through the system remains constant and the difference between the inlet and outlet mass water vapor is the mass evaporated in the scrubber.

This subsection presents a procedure for estimating the waste gas outlet conditions and the water evaporated in the scrubber. The procedure uses a psychrometric chart. The thermodynamic variables on the chart are defined in the following paragraph. Commercial computer programs are now available that directly calculate the variables on the chart.

Moisture content refers to the volume of water vapor in a given volume of gas. Moisture content is given by the equation:

$$\theta_{H_2O} = \frac{V_{wv}}{(V_a + V_{wv})} \quad (2.6)$$

The humidity ratio, or absolute humidity is the ratio of the mass of dry air to water vapor:

$$\omega = \frac{m_v}{m_a} \quad (2.7)$$

where  $\omega$  = humidity ratio.

This differs from relative humidity, which is the ratio of the water vapor partial pressures at the current conditions and at saturation for a given temperature. The relationship between moisture content,  $\theta_{H_2O}$ , and the humidity ratio,  $\omega$ , for an ideal gas is given as:

$$\theta_{H_2O} = \frac{\frac{\omega}{MW_a}}{\left(\frac{1}{MW_{wv}} + \frac{\omega}{MW_a}\right)} \approx \omega \frac{MW_{wv}}{MW_a} \quad (2.8)$$

where  $MW_{wv}, MW_a$  = molecular weight of water vapor and air, respectively.

In order to use the psychometric chart, the waste gas properties must be known at standard conditions (or the conditions of the chart, if different from standard). The properties are determined for standard conditions using the Ideal Gas Law:

$$\frac{P_1 V_1}{T_1} = \frac{P_2 V_2}{T_2} \quad (2.9)$$

where temperature is in units of degrees Kelvin. Assuming constant pressure, the volume of the waste gas at standard temperature can be calculated as:

$$V_2 = V_1 \frac{T_2}{T_1} \quad \text{or} \quad Q_2 = Q_1 \frac{T_2}{T_1} \quad (2.10)$$

where  $Q_2$  = waste gas outlet volume flow rate (air and water vapor,  $Q_m$ ) at standard conditions.

The relationship between the mass and volume of an ideal gas can be calculated from its volume at standard temperature and pressure using the equation:

$$\dot{m} = Q \frac{MW}{V_{mole}} \quad (2.11)$$

where  $\dot{m}$  = mass flow rate,  
 $MW$  = molecular weight, and  
 $V_{mole}$  = volume of one mole of air  
 = 22.4 liters per gmole (385 ft<sup>3</sup> per lbmole).

Moisture content (or humidity ratio) is used to calculate the mass flow rate of dry air and water vapor at the inlet using Equation 2.11:

$$\begin{aligned} \dot{m}_{wv(in)} &= [Q_{m(in)} \times \theta_{H_2O(in)}] \frac{MW_{wv}}{V_{mole}} \\ \dot{m}_{a(in)} &= [Q_{m(in)} (1 - \theta_{H_2O(in)})] \frac{MW_{wv}}{V_{mole}} \end{aligned} \quad (2.12)$$

Note this is the mass flow rate at standard conditions. The inlet humidity ratio,  $\omega_{(in)}$  at standard conditions can now be calculated as well using Equation 2.7.

### 2.5.3.1 Psychrometric Chart

Figure 2.9 is an example of a psychrometric chart at standard atmospheric conditions, 14.7 pounds per square inch (psi). The dry bulb temperature is typically the x-axis of the chart. The dry bulb temperature is the temperature of the waste gas mixture of water vapor and air, or the temperature measured by an ordinary thermometer. The chart's y-axis has a scale for both the humidity ratio and relative humidity. The y-axis to the far right on the chart is the saturation curve, representing a relative humidity of 100%. Lines that slant upward to the left are generally lines of constant wet bulb temperature, specific volume, and enthalpy. The specific volume of the air-water vapor mixture, or humid volume, is the volume of the mixture per unit mass of dry air.

Use the chart to determine outlet conditions at saturation. First, fix a point on the chart based on the dry bulb temperature and humidity ratio. Follow the corresponding line of constant enthalpy (adiabatic saturation line) to the saturation curve on the left. This is the location for reading the outlet conditions of the waste gas. This is the point at which the maximum water from the scrubber has evaporated into the waste gas. Note that the mass of the dry air is conserved during the process,  $m_{a(in)} = m_{a(out)}$ .

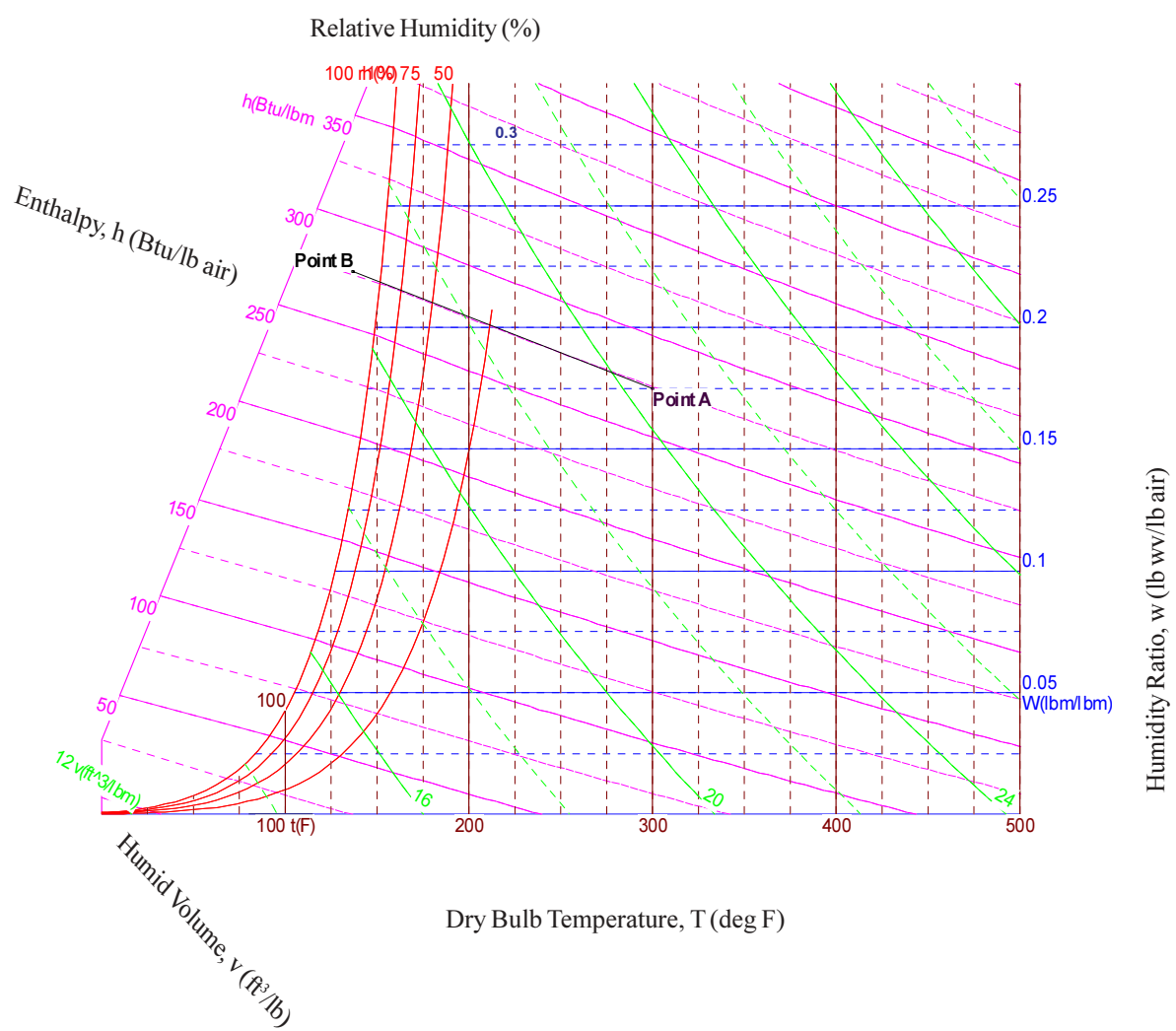

**Figure 2.9:** Psychrometric Chart at Standard Pressure, 14.7 psi  
 (Chart developed using Akton Psychrometrics, Akton Associates, Inc.)

The volumetric flow rate of the waste gas at the outlet of the scrubber can now be determined. Using the dry air mass flow rate and the humid volume,  $v$ , read from the chart, the volume of saturated air per unit mass of dry air, obtained from the chart, the volumetric flow rate is:

$$Q_{m(out)} = v \dot{m}_a \tag{2.13}$$

where  $v$  = humid volume of saturated air

The outlet humidity ratio can be used to calculate the mass of water vapor in the waste gas at the outlet of the scrubber:

$$\dot{m}_{wv(out)} = \omega_{(out)} \dot{m}_a \quad (2.14)$$

Additional water must be added to the scrubber system to make up for the water lost to evaporation. By determining the difference between the inlet and outlet humidity of the waste gas stream, the volume of water evaporated can be calculated. The mass of water evaporated through the scrubber is:

$$\dot{m}_{wv(evap)} = \dot{m}_{wv(out)} - \dot{m}_{wv(in)} \quad (2.15)$$

The volume flow rate of make up water is given by:

$$Q_{wv(evap)} = \frac{\dot{m}_{wv(evap)}}{\rho_{H2O}} \quad (2.16)$$

#### 2.5.4 Scrubber Design

In general, wet scrubber manufacturers guarantee a collection efficiency for a specific design. This collection efficiency is dependent on both the liquid to gas ratio, gas velocity in the venturi and pressure drop. The L/G ratio and pressure drop impact the O&M cost while the venturi gas velocity impacts the capital cost. (See Section 1 Chapter 2 for a discussion of capital and annual costs.) Therefore, there is no straightforward design approach. An iterative approach must be utilized which looks at both capital and annual costs. The relationship between L/G ratio, gas velocity in the venturi, and pressure drop is shown in Figure 2.10 for a venturi scrubber.

A number of methods for estimating venturi design parameters have been developed by various researchers. This chapter presents four of the most common methods used by designers. For more theoretical discussions of scrubber design equations, such as calculating pressure drop for a specific particle diameter, refer to References [1, 2, and 4]

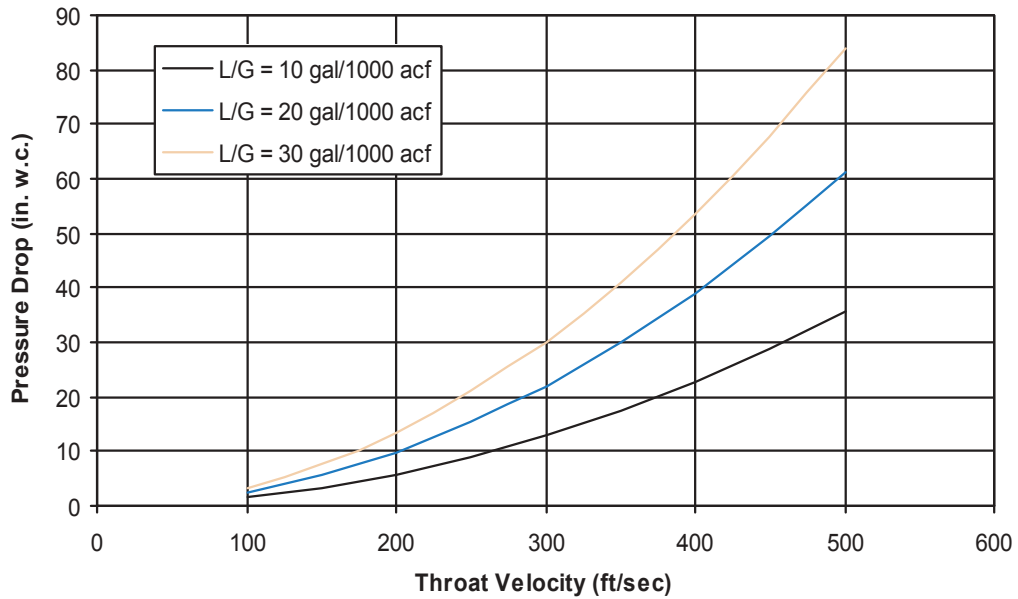

**Figure 2.10:** Relationship between Pressure Drop, Throat Velocity and L/G

2.5.4.1 Estimating Pressure Drop

2.5.4.1.1 Pressure Drop Equations

Most pressure drop equations for venturi scrubbers are of the form:

$$\Delta P = k v^2 \rho_g \left( \frac{L}{G} \right) \quad (2.17)$$

where  $\Delta P$  = pressure drop across venturi ,  
 $v$  = throat velocity,  
 $\rho_g$  = gas density,  
 $L/G$  = liquid to gas ratio, and  
 $k$  = correlation factor for a specific scrubber design.

One of the more widely accepted equations for estimating pressure drop across a venturi scrubber was published by Calvert [24]. The pressure drop is given as:

$$\Delta P = 5.4 \times 10^{-4} v^2 \rho_g \left( \frac{L}{G} \right) \quad (2.18)$$

where  $\Delta P$  = pressure drop across venturi in inches of water (in H<sub>2</sub>O),  
 $v$  = throat velocity in feet per second (ft/s),  
 $\rho_g$  = saturated gas stream density in pounds per cubic feet (lb/ft<sup>3</sup>), and  
 $L/G$  = liquid to gas ratio in gallons per 1000 cubic feet (gal/1000 ft<sup>3</sup>).

The Calvert equation predicts pressure drop reasonably well at moderate liquid to gas ratios. At ratios between 3 gal/1000 ft<sup>3</sup> and 10 gal/1000 ft<sup>3</sup> the equation was found to perform well, but at or above 12 gal/1000 ft<sup>3</sup> the equation over predicts the pressure drop by 80% or more [13].

A model for pressure drop published by Hesketh is also widely used [16]. The model is based upon a correlation of experimental data obtained from many different venturi scrubbers. Hesketh's equation for pressure drop is given by:

$$\Delta P = \frac{v^2 \rho_g A^{0.133}}{507} \left( 0.56 + 0.125 \left( \frac{L}{G} \right) + 0.0023 \left( \frac{L}{G} \right)^2 \right) \quad (2.19)$$

where  $\Delta P$  = pressure drop across venturi in inches of water (in H<sub>2</sub>O),  
 $v$  = throat velocity in feet per second (ft/s),  
 $\rho_g$  = saturated gas stream density in pounds per cubic feet (lb/ft<sup>3</sup>),  
 $A$  = the cross-sectional area of the throat in square feet (ft<sup>2</sup>), and  
 $L/G$  = liquid to gas ratio in gallons per 1000 cubic feet (gal/1000 ft<sup>3</sup>).

This equation is often simplified to:

$$\Delta P = \frac{v^2 \rho_g A^{0.133} \left( \frac{L}{G} \right)^{0.78}}{1270} \quad (2.20)$$

Hesketh experimentally determined a relationship between pressure drop and collection efficiency [2]. Based on the collected data, Hesketh concluded that the venturi is essentially 100% efficient for particles greater than 5  $\mu$ m. He developed a correlation between pressure drop and penetration for particles sizes below this value, given by:

$$Pt = \frac{C_i}{C_o} = 3.47 \Delta P^{-1.43} \quad (2.21)$$

where  $C_i$  and  $C_o$  = concentration of particles <5  $\mu$ m at inlet and outlet of the venturi on a mass basis, and  
 $\Delta P$  = pressure drop, in H<sub>2</sub>O.

Figure 2.6 presents pressure drop for a rectangular venturi scrubber. [2]



2.5.4.1.2

Contact Power Theory

Contacting power is defined as the energy dissipated per unit volume of gas treated. The contact power theory was developed by Lapple and Kamack [17] and extended by Semrau [18,19]. It states that all scrubbers give the same degree of particle collection at the same level of power consumption regardless of how the power is obtained, either from the gas phase pressure drop, the liquid phase atomization, or mechanical means. It is often referred to as the “Equivalent Energy Theory”

The total contact power,  $P_T$ , given by:

$$P_T = P_G + P_L + P_{mech} \quad (2.22)$$

where  $P_T$  = total contact power,  
 $P_G$  = power due to pressure drop of gas passing through the scrubber,  
 $P_L$  = power due to the scrubber liquid atomization, and  
 $P_{mech}$  = power due to mechanical devices to increase contact, i.e., a rotor.

Contacting power is determined from the friction loss across the wetted portion of the scrubber [5]. Pressure loss due to gas stream kinetics is assumed to be negligible.

$P_G$  is the contacting power from the gas stream energy input, generally expressed as horsepower per 1000 cubic feet per minute under actual conditions, (hp/1000 acfm). For most wet scrubbers,  $P_G$  dominates the total contact power equation. It is estimated from the measured pressure drop across the scrubber as:

$$P_G = 0.157\Delta P \quad (2.23)$$

where  $\Delta P$  = pressure drop across venturi, in  $H_2O$ .

The contacting power from the liquid stream energy input,  $P_L$ , is also expressed as hp/1000 acfm. It is based on the liquid to gas ratio and given by:

$$P_L = 0.583 p_L \left( \frac{L}{G} \right) \quad (2.24)$$

where  $p_L$  = liquid inlet pressure in pounds per square inch (psi), and  
 $L/G$  = liquid to gas ratio in gallons per cubic feet (gal/ft<sup>3</sup>).

Table 2.1 presents the operating parameters for several scrubber types.

**Table 2.1:** Operating Parameters for Particulate Wet Scrubbers, [2, 12]

Scrubber Type	Pressure Drop (in. H <sub>2</sub> O)	L/G Ratio (gal/1000 acf)	Liquid Pressure (psig)	Gas Velocities (ft/sec)	Cut Diameter (μm)
Spray Tower	0.5-3	0.5-20	10-400	10	2-8
Cyclonic	2-10	2-10	10-400	105-140b	2-3
Venturi	10-150	2-20	0.5-2	90-400c	0.2

Contacting power is correlated to the scrubber collection efficiency,  $\eta$ . This correlation is often expressed as the number of “transfer units”, a dimensionless number defined by the equation:

$$N_t = \ln\left(\frac{1}{1-\eta}\right) \quad (2.25)$$

The number of transfer units for a given contacting power depends on the scrubber type and the characteristics of the particulate matter. For a given scrubber and particulate type, the relationship between transfer units and contact power is:

$$N_t = \alpha P_T^\beta \quad (2.26)$$

where  $\alpha$  and  $\beta$  are empirical coefficients which are characteristic of the scrubber type and particulate being collected. Table 2.2 presents the coefficients for various scrubber types. [2, 14] The pressure drop associated with that collection efficiency can then be calculated.

**Table 2.2:** Contact Power Scrubber Correlation Parameters, [2, 14]

Aerosol	Scrubber	$\alpha$	$\beta$
Lime kiln dust	Venturi and cyclonic spray	1.47	1.05
Prewashed lime kiln dust	Venturi, pipe line, and cyclonic spray	0.915	1.05
Talc dust	Venturi	2.97	0.362
Talc dust	Orifice and pipe line	2.7	0.362
Phosphoric acid mist	Venturi	1.33	0.647
Foundry cupola dust	Venturi	1.35	0.621
Open hearth steel furnace	Venturi	1.26	0.569
Talc dust	Cyclone	1.16	0.655
Ferrosilicon furnace	Venturi and cyclonic spray	0.870	0.459
Odorous Mist	Venturi	0.363	1.41

### 2.5.4.1.3 Performance Curves

A performance curve is the scrubber's collection efficiency as a function of the particle diameter at a specified pressure drop. The curves are specific to a given venturi design. In general, multiple curves are presented for various pressure drops. Performance curves must be obtained from vendors. Figure 2.6 is an example of a performance curve for a rectangular venturi [2].

The overall collection efficiency must be calculated to obtain the total penetration of all PM. The overall collection efficiency is the sum of the fractional collection efficiencies in each particle size range. This calculation is presented in Section 2.5.2, Equation 2.4. The collection efficiency for each size range is read off a performance curve. The fractional collection efficiency is the mass fraction of the size range multiplied by the collection efficiency for that range. Summing these values gives the cumulative collection efficiency,  $\eta_d$ , at a specific pressure drop. The total penetration,  $P_p$ , can be calculated from  $\eta_d$  using equation 2.5.

Since each pressure drop has its own curve, the total penetration at several pressure drops must be calculated using the above procedure. Then, the total penetration,  $Pt_p$  is plotted for each pressure drop as shown in Figure 2.11. The design pressure drop across the scrubber is read from the graph based on the required total penetration.

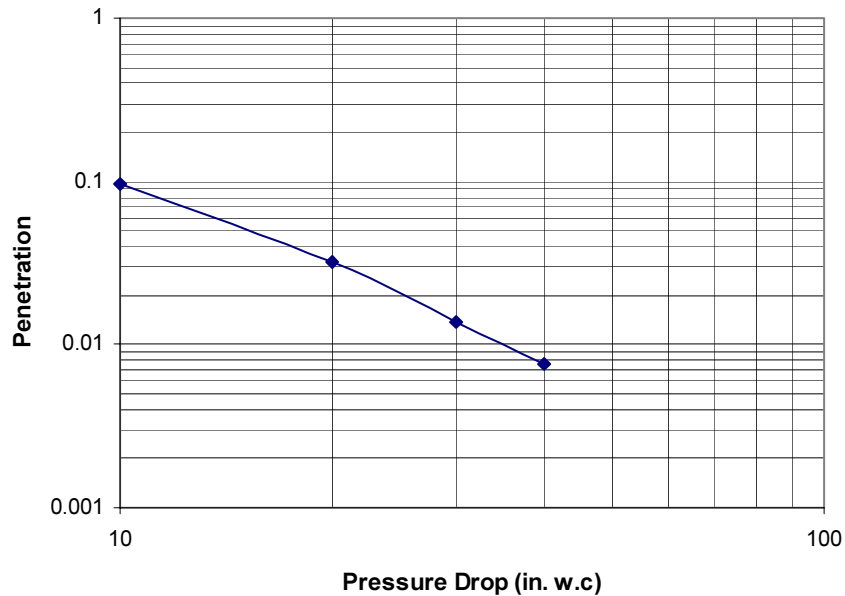

**Figure 2.11:** Penetration vs. Pressure Drop as Determined from Performance Curves

#### 2.5.4.1.4 Calvert Cut Diameter Method

The method assumes that the most significant design parameter for a wet scrubber is the particle diameter that is collected at 50% efficiency or the “cut diameter” [20]. Utilizing this approach requires a log-normal particle size distribution. It relates the cut diameter to the overall collection efficiency and the size distribution parameters.

The scrubber penetration is modeled as an exponential function of the aerodynamic diameter given by:

$$Pt_j = e^{\left(-A d_j^B\right)} \quad (2.27)$$

where  $Pt_j$  = penetration of the jth particle diameter,  
 $d_j$  = diameter of the jth particle size, and  
 $A, B$  = empirical constants.

B is a constant that is scrubber specific. B is equal to 2.0 for venturi, packed bed, and tray wet scrubbers and B is equal to 0.67 for cyclonic wet scrubbers.

The overall penetration is given by:

$$Pt_d = \int Pt_j m_j \quad (2.28)$$

where  $Pt_d$  = overall penetration,  
 $Pt_j$  = penetration of the jth particle diameter size, and  
 $m_j$  = mass fraction of the jth particle diameter size.

The Calvert Cut Diameter approach uses the cut ratio defined as:

$$Cut\ Ratio = \frac{d_{cut}}{d_{50}} \quad (2.29)$$

where  $d_{cut}$  = the required cut diameter, and  
 $d_{50}$  = the mass median aerodynamic diameter.

Section 2.5.1 PM Distribution and Loading presents calculations for the mass median particle diameter and standard deviation of a log-normal distribution.

The design requirement for overall penetration and the standard deviation of the distribution define the cut diameter. Cut diameter can be obtained graphically using vendor-specific cut diameter performance curves. Figure 2.12 and Figure 2.13 from the equipment guide published by Calvert Environmental Equipment, Inc., presents penetration as a function of the standard deviation of the distribution and cut ratio. Note that Figure 2.13 is the same as Figure 2.12 but it assumes  $B = 2.0$ . The required cut ratio is read from the curve and used to calculate cut diameter.

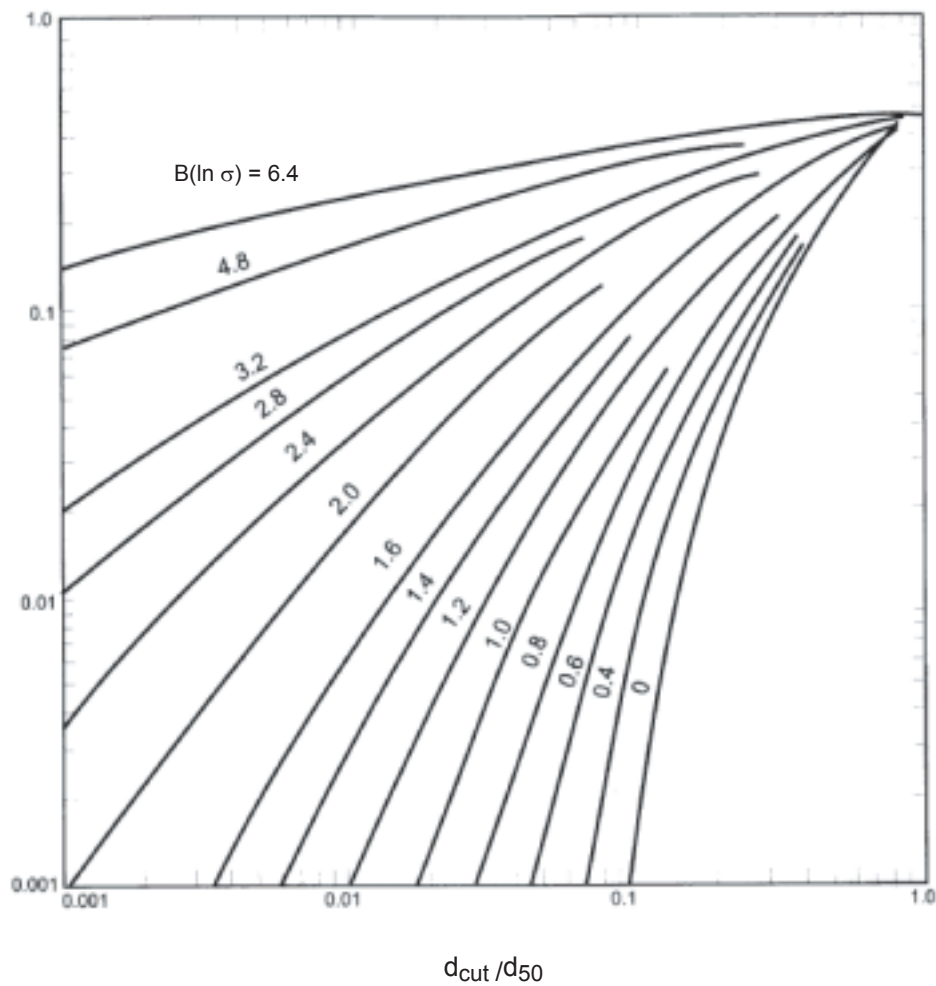

**Figure 2.12:** Cut Diameter as a Function of Cut Ratio and Standard Deviation of the Particle Size Distribution [20]

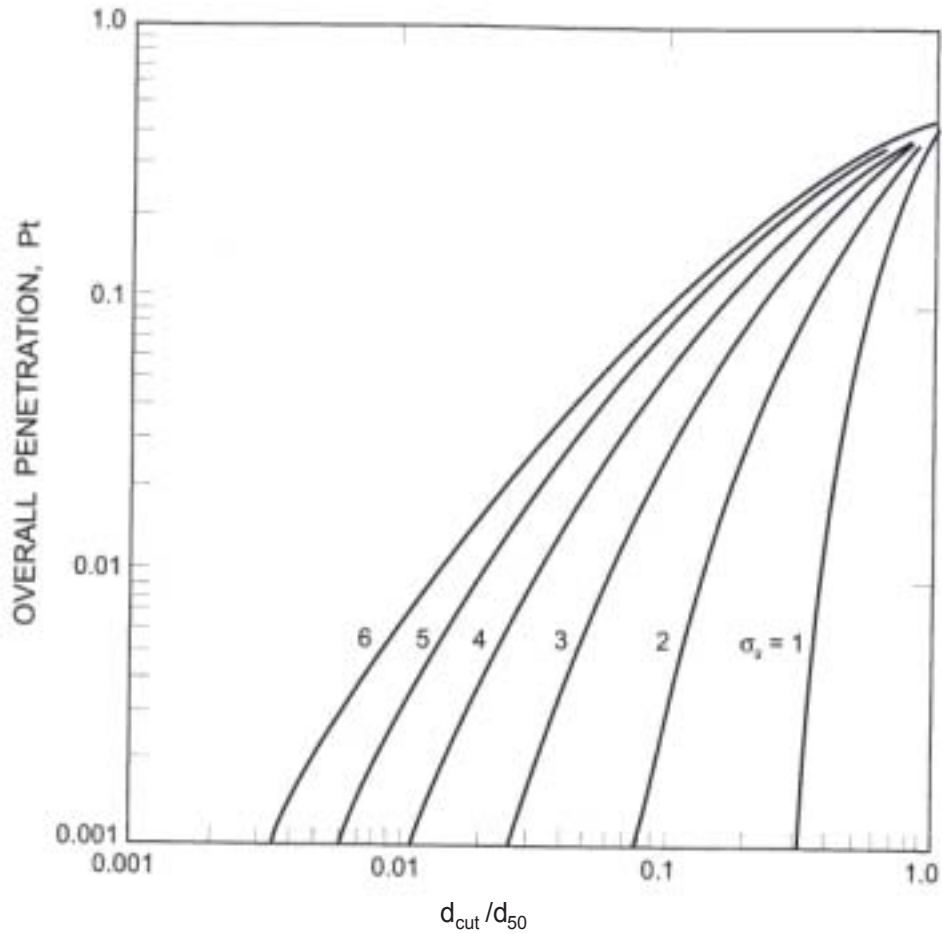

**Figure 2.13:** Cut Diameter as a Function of Cut Ratio and Standard Deviation of the Particle Size Distribution for  $B = 2.0$ , [20]

Once cut diameter is known, the pressure drop and scrubber power, horsepower per 1,000 acfm of gas scrubbed, can be read from another vendor-specific performance curve. An example of this type of performance curve is given by Figure 2.14. It presents the pressure drop and scrubber power for several types of scrubbers. The power requirement of this figure assumes a fan efficiency of 50%. To obtain power requirements at other efficiencies, use the following relationship:

$$Power_{\eta_2} = Power_{\eta_1} \frac{\eta_1}{\eta_2} \quad (2.30)$$

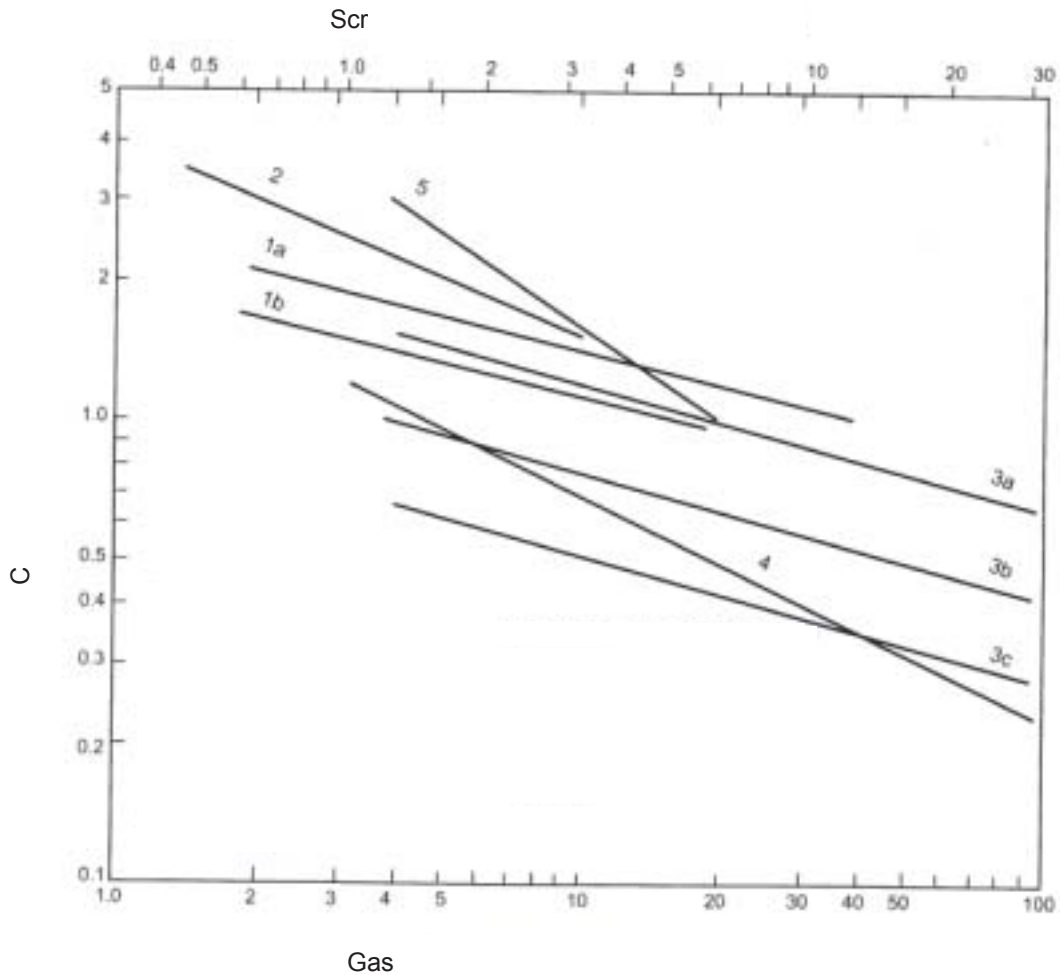

- 1a. Sieve-plate column with foam density of 0.4 g/cm<sup>3</sup> and 0.2-in hole dia. The number of plates does not affect the relationship much. (Experimental data and mathematical model.)
- 1b. Same as 1a except 0.125-in hole-dia.
- 2. Packed column with 1-in rings or saddles. Packing depth does not affect relationship much. (Experimental data and mathematical model.)
- 3a. Fibrous packed bed with 0.012-in dia. Fiber – any depth. (Experimental data and mathematical model.)
- 3b. Same as 3a except 0.004-in. dia. Fibers
- 3c. Same as 3a except 0.002-in. dia. Fibers
- 4. Gas atomized spray.
- 5. Mobile bed with 1-3 stages of fluidized hollow plastic spheres. (Experimental data from pilot plant and large-scale power plant scrubbers)

**Figure 2.14:** Scrubber Power and Pressure Drop as a Function of Cut Diameter, [23]

#### 2.5.4.2 Scrubber Velocity and Cross-Sectional Area

Any of the four approaches discussed previously can be used to estimate the pressure drop that is required to attain a given collection efficiency. This pressure drop determines the required gas velocity in the venturi throat. Throat velocity depends on:

- mixture of gas and scrubbing liquid and L/G ratio,
- turbulence,
- distribution of liquid-gas mixture and PM across the throat, and
- hydraulic losses through the throat.

Throat velocity is limited by the acceptable gas velocities in downstream scrubber equipment such as the mist eliminator.

There are theoretical equations available for calculating throat velocity, however, most manufacturers determine throat velocity experimentally. The throat velocity and cross-sectional area can be estimated using a modified Bernoulli equation: [12]

$$v_t = \frac{Q_m}{A_t} = C \sqrt{\frac{\Delta P}{\rho_{sat}}} \quad (2.31)$$

where

$v_t$	= velocity at the throat,
$A_t$	= cross-sectional area of the throat,
$Q_m$	= maximum actual volumetric air flow rate,
$\rho_{sat}$	= density of the gas at saturation, and
$C$	= constant.

C is a function of the L/G ratio. A relationship between C and L/G was developed for venturis with a 30° converging section, a 10° to 12° diverging section, and a gas density of 0.06 lb/ft<sup>3</sup> [12]:

$$C = 1060 e^{(-0.279 L/G)} \quad (2.32)$$

Increasing the gas density above 0.075 causes the value of C, and hence  $v_t$ , to increase rapidly due to increased resistance of the gas.

The throat cross-sectional area is calculated from the scrubber inlet and throat velocities:

$$A_t = A_i \frac{v_i}{v_t} \quad (2.33)$$

where  $A_t$  and  $A_i$  = area of the throat and inlet, respectively.



From the cross-sectional area of the throat, the dimensions of the throat can be estimated. The diameter for a circular throat and the width of a rectangular throat can be calculated as:

$$d_t = \sqrt{\frac{4A_t}{\pi}} \text{ for circular throat}$$

$$d_t = \sqrt{A_t} \text{ for rectangular throat}$$
(2.34)

The length of the throat and diverging section of the venturi is optimized for pressure recovery. For optimal pressure recovery, the length of the throat is generally on the order of 3 times the throat diameter (or width) and the length of the diverging section is generally 4 times the throat diameter (or width).

$$l = 3 d_t$$

$$l_{div} = 3 d_t$$
(2.35)

The flow path of the gas exiting the venturi is often turned 90° prior to entering the particle separator. Due to the high velocity of the gas, the pressure drop from turning the flow can be high. The radius of the elbow duct section must be sufficiently large to minimize the pressure drop across the joint. See Section 2, Chapter 1 Hoods Ducts and Stacks for sizing and costing of duct sections. Design of cyclones and mist eliminators is beyond the scope of this document. Several of the references discuss design of these components including [2, 3, and 4].

## 2.5.5 Consumables

### 2.5.5.1 Water Usage

Most wet scrubbers systems recirculate the scrubbing liquid. In order to decrease the solids content of the scrubbing liquid, part of the liquid is bled from the system and fresh water is added. Venturi scrubbers typically have peak solids concentrations of 20 to 30% [1]. A higher PM loading of the gas stream requires a higher bleed rate resulting in a greater volume of liquid waste and higher disposal costs.

The mass flow of particulate matter into the scrubber liquid is:

$$\dot{m}_{PM} = \eta L_{PM} Q_i$$
(2.36)

where  $\dot{m}_{PM}$  = mass flowrate of PM,  
 $\eta$  = overall collection efficiency of the scrubber,  
 $L_{PM}$  = PM loading at the inlet, and  
 $Q_i$  = waste gas flow rate at the inlet.

Using the density of water, 1.0 kg/l (8.3 lb/gal), and the design solids concentration, a bleed rate for the scrubber liquid can be calculated as:

$$Q_{bleed} = \frac{\dot{m}_{PM}}{f_{solids} \rho_{H2O}} \quad (2.37)$$

where  $Q_{bleed}$  = bleed rate, and  
 $f_{solids}$  = mass fraction of solids in recirculation water.

The total flow rate of water required by the system,  $Q_T$ , is the sum of the water evaporated and the bleed water given by:

$$Q_{T(H2O)} = Q_{wv(evap)} + Q_{bleed} \quad (2.38)$$

The total water consumed annually is given by:

$$V_{T(H2O)} = Q_{T(H2O)} t \quad (2.39)$$

where  $V_{T(H2O)}$  = annual volume of water consumed, and  
 $t$  = scrubber operating time per year.

For a jet venturi system that uses a pneumatic spray system, the air usage must also be included as a consumable.

### 2.5.5.2 Electrical Power Usage

From the pressure drop across the system, the required fan brake horsepower can be calculated using the following equation from Section 1:

$$HP_{fan} = \frac{\Delta P Q_i}{6356 \eta_{fan}} \quad (2.40)$$

where  $HP_{fan}$  = fan brake horsepower, hp,  
 $\eta$  = efficiency of the fan, and  
 $\Delta P$  = pressure of the fan, in w.c.

The brake horsepower required for pump to recirculate the scrubbing liquid through the system is calculated similarly as:

$$HP_{pump} = \frac{\Delta P_{pump} \text{ L/G} \frac{Q_i}{1,000} \gamma}{3952.6 \eta_{pump}} \quad (2.41)$$

where  $HP_{pump}$  = pump brake horsepower, hp,  
 $\eta_{pump}$  = efficiency of the fan,  
 $\Delta P_{pump}$  = pressure of the pump, feet w.c.,  
 $\text{L/G}$  = liquid to gas ratio, gal/1000 ft<sup>3</sup>,  
 $Q_i$  = flow rate at inlet, acfm, and  
 $\gamma$  = specific gravity of the scrubbing liquid.

For a jet venturi system, the pump or compressor requirements for the pneumatic or hydraulic nozzle system must also be included in the energy consumption calculations. Table 2.3 presents typical pump and fan requirements for various scrubbers.

**Table 2.3:** Pump and Fan Energy Requirements (1,000 cfm;  $\eta=90\%$  at  $\mu\text{m}$ ), [13]

Type of unit	Liquid flow (gpm)	Pressure (psig)	Pump hp	$\Delta P$ of gas (in.wg)	Fan hp	Relative hp/ 1,000cfm
Wet Cyclone	10	60	0.91	8	2.5	3.41
Venturi	10	20	0.233	15	3.94	4.27
Jet Venturi	40	70	3.28	0	0	3.28

## 2.6 Cost Analysis

The cost estimation methodology presented here provides a tool to estimate study-level venturi wet scrubber capital and annual costs. The cost equations and factors for venturi scrubbers are based on the method given in *Estimating Costs of Pollution Control Equipment*. [12] The reader should not be surprised if vendor quotes are obtained that differ from these estimates by as much as  $\pm 25$  percent since they represent study level costs. Actual selection of the most cost-effective option should be based on a detailed engineering study and cost quotations from system suppliers. The costs are in 2002 dollars. Costs can be adjusted to other years using the Chemical Engineering Cost Index or the VAPCCI index for venturi scrubbers.

The cost equations apply to industrial sources of  $PM_{10}$  and  $PM_{2.5}$  with air flow rates between 100 acfm and 200,000 acfm. Extrapolation to flow rates beyond those presented is not appropriate. Overall collection efficiency ranges from 97% to 99.9%. The waste gas is assumed to have nominal values for PM distribution, PM loading rates, temperatures, and moisture content.

### 2.6.1 Total Capital Investment

Total Capital Investment (TCI) includes costs associated with purchasing the venturi unit and direct and indirect costs associated with installing the unit. The equation for TCI is given by:

$$TCI = PEC + DC + IC \quad (2.42)$$

where

PEC	=	purchased equipment costs
DC	=	direct installation costs
IC	=	indirect installation costs.

In general, installing a venturi wet scrubber does not require construction of buildings, site reparation, offsite facilities, land, and working capital. A more detailed discussion of TCI can be found in Section 1, Chapter 2 of this Manual.

#### 2.6.1.1 Purchased Equipment Cost

The Purchased Equipment Cost (PEC) of a venturi wet scrubber system is the sum of the costs of the venturi equipment, instruments and controls, taxes, and freight. The last three items generally are taken as percentages of the equipment costs. Table 2.4 gives typical values for instruments and controls, taxes, and freight.

**Table 2.4:** Cost Estimates for Instrumentation, Taxes and Freight

Item	Percentage of Equipment Cost
Instruments and Controls	10%
Taxes	3%
Freight	5%

Venturi equipment cost equations were developed by performing a least squares regression of cost data provided by three vendors. Costs were provided for three types of package venturi systems; fixed throat venturi, jet venturi, and variable throat venturi. Package systems were assumed to include the following basic equipment:

- venturi,
- liquid injection system,
- cyclone, and
- mist eliminator.

Additional equipment required for the venturi but not included in the cost estimate include the following:

- recycle pump,
- ID fan,
- piping and valves, or
- basic instrumentation and controls

The equipment cost of the packaged venturi system varies in direct proportion to the waste gas flow rate. Note that this flow rate corresponds to the saturated waste gas,  $Q_{sat}$ , not the inlet waste gas flow rate [24]. The cost equations use saturated waste gas volume since the actual flow rate can vary widely based on temperature, humidity and pressure.

The cost of a venturi per cubic foot of gas treated decreases as volume of gas increases due to economy of scale. However, if the scrubber becomes too large to be shipped as a package unit and must be field erected, the cost per cubic foot of gas treated increases. A venturi unit requires field erection when the cyclone separator diameter exceeds the shippable diameter, generally 12.5 feet inner diameter. This is equivalent to approximately 90,000 to 100,000 acfm of saturated gas [24].

Table 2.5 presents the equipment cost equations for each type of package venturi system. The equations are for venturi systems constructed of carbon steel and Alloy C-276. Table 2.6 gives multipliers for other materials including 304 and 316 stainless steel, fiberglass reinforced plastic (FRP), rubber coated steel, and epoxy coated steel. The equipment costs are “free on board” (FOB) which means that no taxes or freight are included. The cost of additional equipment (pumps, fans, etc.) is generally 80% to 100% of the package venturi system cost. Figures 15 through 17 present the cost equations as a function of flowrate.

**Table 2.5:** Venturi Equipment Costs, 2002 Dollars

Type of Venturi Unit	Saturated Air Flow Rate Range (cfm)	Equipment Cost Equation, \$	
		Carbon Steel	Alloy C-276
low energy	1,000 to 90,000	= $150 Q_{sat}^{0.56}$	= $900 Q_{sat}^{0.5}$
high energy	1,000 to 90,000	= $170 Q_{sat}^{0.56}$	= $1,300 Q_{sat}^{0.5}$
packaged jet venturi <sup>1</sup>	100 to 10,000	= $4.5 Q_{sat} + 19,000$	N/A
variable throat	1,000 to 90,000	= 1.1 to 1.15 of the fixed throat cost	

<sup>1</sup> The jet venturi costs includes recycle pump, ID fan, piping and valves, basic instrumentation, and mounting skid.

**Table 2.6:** Equipment Cost Factors for Venturi Units Constructed of Other Materials

Material	Equipment Cost Factor
Stainless Steel, 304L	1.08 - 1.16
Stainless Steel, 316L	1.25 - 1.40
Fiberglass Reinforced Plastic (FRP)	1.6 <sup>1</sup>
Rubber Lining	1.6 <sup>1</sup>
Epoxy Coating	1.1 <sup>1</sup>

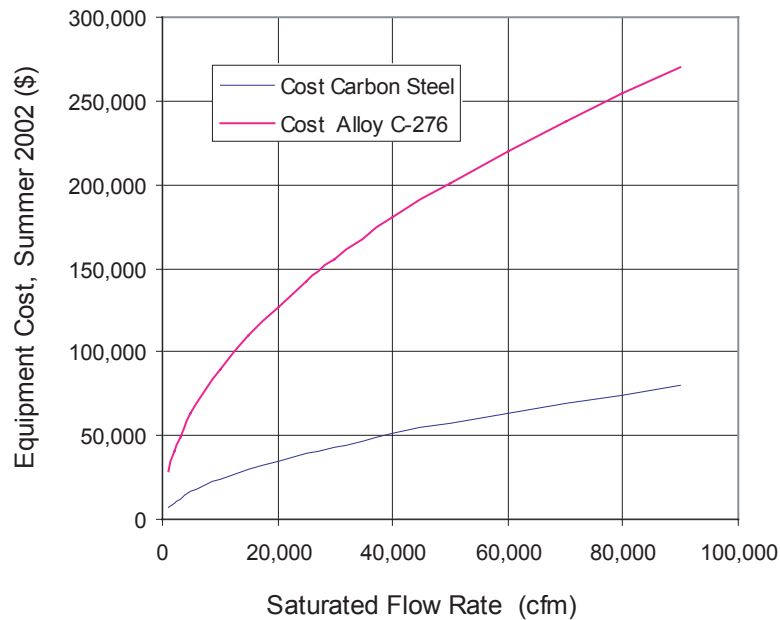

**Figure 2.15:** Equipment Costs for Low Energy Venturi

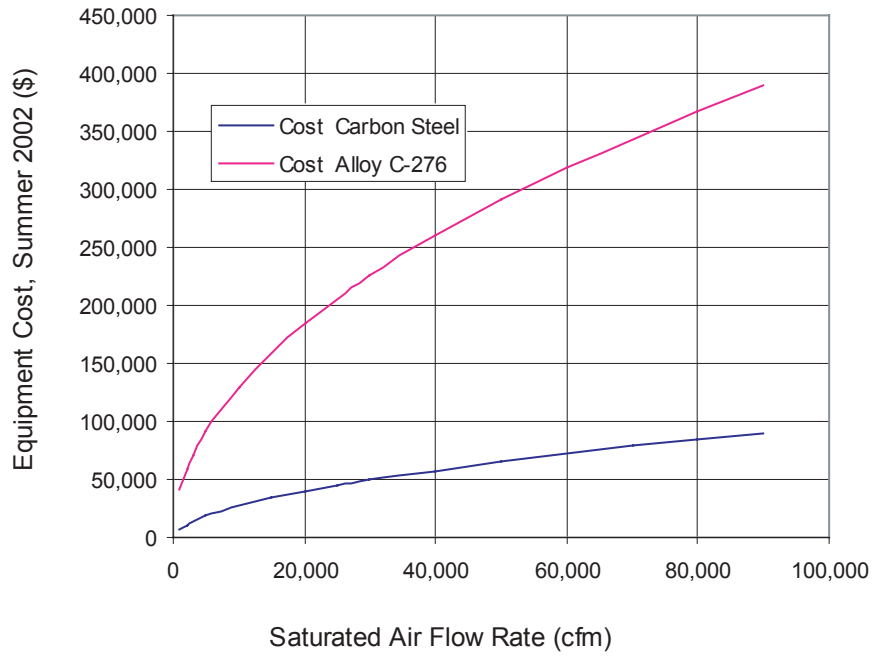

**Figure 2.16:** Equipment Costs for High Energy Venturi

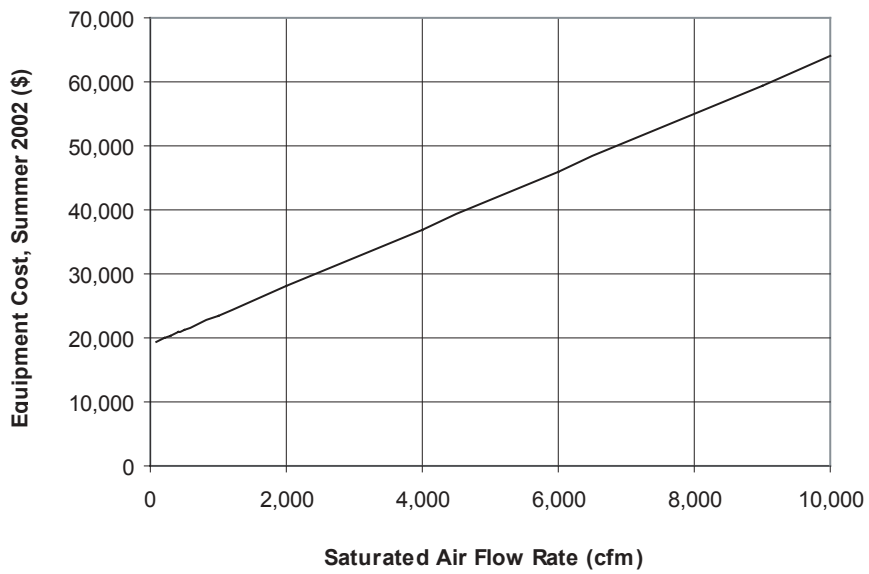

**Figure 2.17:** Equipment Costs for Jet Venturi

Higher pressure drops, require a greater thickness of the material of construction or stiffening of the material. The cost of the scrubber increases with the thickness of the material utilized. Venturi systems with pressure drops above 15 in w.c. generally require greater thickness or stiffening. For control of PM<sub>10</sub>, the pressure drop is generally under 20 in w.c. while control of PM<sub>2.5</sub> generally requires a pressure drop of 25 in w.c. or greater [24]. Table 2.7 presents typical pressure drops and materials of construction for various applications.

**Table 2.7:** Typical Venturi Scrubber Applications and Materials of Construction, [5, 24]

<b>Application</b>	<b>Pressure Drop (in.wg)</b>	<b>Material of construction</b>
<u>Boilers</u>		
Pulverized coal	15 - 40	316L stainless steel
Stoker coal	10 - 12	316L stainless steel
Bark	6 - 12	Carbon steel or stainless steelk
Combination	10 - 15	316L stainless steel
Recovery	30 - 40	Carbon, 316L stainless, or alloy steel
<u>Incinerators</u>		
Sewage sludge	18 - 20	316L stainless steel
Liquid waste	50 - 55	High nickel alloy
<u>Solid waste</u>		
Municipal	20 - 35	316L stainless steel or alloy steel
Pathological	20 - 35	316L stainless steel or alloy steel
Hospital	20 - 45	High nickel alloy
<u>Kilns and calciners</u>		
Lime	15 - 25	Carbon steel or stainless steel
Soda ash	20 - 40	Carbon steel or stainless steel
Potassium chloride	30	Carbon steel or stainless steel
<u>Other</u>		
Dryers	10 - 25	304 or 316L stainless steel
Crushers	6 - 20	Carbon steel
General spray dryer	15 - 30	Carbon steel or stainless steel

Note: Alloy steels may be required if corrosive halides are present



### 2.6.1.2 Direct and Indirect Installation Costs

Direct installation costs include materials and labor costs associated with installing the venturi unit. These costs include; auxiliary equipment (e.g., ductwork, compressor), foundations and supports, handling and erection, electrical, piping, insulation and painting. Indirect installation costs include engineering and supervision, construction and contractor fees, startup and testing, inventory capital, and any process and project contingency costs. Using the methodology presented in Section 1 of the *Manual*, Introduction and Cost Methodology, direct and indirect installation costs are estimated from a series of factors applied to the purchased equipment cost. The required factors are given in Table 2.8.

**Table 2.8:** Direct and Indirect Installation Costs for Venturi Scrubbers, [12]

<b>Cost Item</b>	<b>Factor</b>
<b>Direct Costs</b>	
Purchased equipment costs	
Venturi Packaged Unit	As estimated, A1
Auxiliary Costs	As estimated, A2
Equipment Costs	$A = A1 + A2$
Instrumentation	$0.10 \times A$
Sales taxes	$0.03 \times A$
Freight	$0.05 \times A$
<b>Purchased Equipment Cost, PEC</b>	<b><math>B = 1.18 \times A</math></b>
Direct installation costs	
Foundations & supports	$0.06 \times B$
Handling & erection	$0.40 \times B$
Electrical	$0.01 \times B$
Piping	$0.05 \times B$
Insulation for ductwork	$0.03 \times B$
Painting	$0.01 \times B$
<b>Direct Installation Costs, DC</b>	<b><math>0.56 \times B</math></b>
Site preparation	As required, SP
Buildings	As required, Bldg.
<b>Indirect Costs (installation)</b>	
Engineering	$0.10 \times B$
Construction and field expenses	$0.10 \times B$
Contractor fees	$0.10 \times B$
Start-up	$0.01 \times B$
Performance test	$0.01 \times B$
Model study	-
Contingencies	$0.03 \times B$
<b>Total Indirect Costs, IC</b>	<b><math>0.35 \times B</math></b>

As discussed in Section 2.3.7, auxiliary equipment required for operation of the venturi may include a pre-cooler, cyclone, hoods, stack, gas re-heater. Costs for hoods, ducts, stacks are presented in Section 2 of this Manual. Capital and O&M costs for cyclones are minimal and easily obtained from vendors. Costs for reheating are dependant on the temperature increase required for the waste gas.

Retrofit installations increase the costs of a venturi wet scrubber because of the common need to remove equipment to create space for the new scrubber. Additional ductwork to re-route the waste gas to the scrubber may also be required. The ducting path is often constrained by existing structures, additional supports are required, and the confined areas make erection more labor intensive and lengthy. Venturi scrubbers have a small footprint, therefore, retrofit costs are generally minimal. While retrofit costs are site-specific, a retrofit multiplier of 1.3 to 1.5 can be applied to the total capital investment to estimate these costs at the study level.

## 2.6.2 Annual Costs

Total annual cost (TAC) consist of direct costs, indirect costs, and recovery credits. No byproduct recovery credits are included because there are no salvageable byproducts generated from wet scrubbers. Therefore, TAC for venturi systems is given by:

$$TAC = DAC + IAC \quad (2.43)$$

where  $DAC$  = Direct Annual Costs, and  
 $IAC$  = Indirect Annual Costs.

Each of these costs is discussed in the sections below. A more detailed discussion of annual costs can be found in Section 1, Chapter 2 of this *Manual*.

### 2.6.2.1 Direct Annual Costs

Direct annual costs (DAC) include variable and semivariable costs. Variable direct annual costs account for purchase of utilities, electrical power, and water. Semivariable direct annual costs include operating and supervisory labor and maintenance (labor and materials).

$$DAC = AC_{labor} + AC_{maint} + AC_{elect} + AC_{water} \quad (2.44)$$

where  $AC_{labor}$  = annual labor cost,  
 $AC_{maint}$  = annual maintenance cost,  
 $AC_{elect}$  = annual electricity cost, and  
 $AC_{water}$  = annual water cost.

The quantity and cost of proprietary additives and waste disposal is application-specific, therefore, these costs are not estimated. Waste disposal costs depend on whether the waste liquid is de-watered and disposed as sludge or disposed in the municipal wastewater system. Waste disposal costs are greatly increased if the waste is classified as special or hazardous waste.

The labor costs are a function of the level of automation. Less labor is required for automatic controls but there are significantly higher capital costs for fully automated scrubber systems. Venturi scrubbers are assumed to require 2 to 8 hours of operating labor per shift [12]. More labor hours may be required for systems with highly variable flow rates, temperatures or pressures. Supervisory labor is assumed to be 15% of the operating labor and maintenance labor per shift, approximately 1 to 2 hours. The cost of materials required for maintenance is assumed to 100% of the maintenance labor cost. [12]

The amount of power and water utilized by the scrubber was estimated in Section 2.5.5. Using the estimated power consumption for the fan and pump,  $HP_{fan}$  and  $HP_{pump}$ , the annual cost of electricity is estimated from the following equation:

$$AC_{elect} = 0.7457 \left( \frac{kW}{hp} \right) (HP_{fan} + HP_{pump}) t Cost_E \quad (2.45)$$

where  $t$  = scrubber operating time per year, hours, and  
 $Cost_E$  = cost of electricity in dollars per kW (\$/kW).

The cost of water is estimated from the total volume of water,  $V_{T(H2O)}$  calculated in Equation 2.39:

$$AC_{H2O} = V_{T(H2O)} Cost_{H2O} \quad (2.46)$$

where  $Cost_{H2O}$  = cost of water in dollars per gallon (\$/gal).

#### 2.6.2.2 Indirect Annual Cost

In general, IAC (fixed cost) includes property taxes, insurance, administrative charges, overhead, and the capital recovery cost. Section 1 of the *Manual* discusses these costs in detail.

Administrative costs, property tax, and insurance are assumed to be percentages of the TCI [12]. Overhead is assumed to be equal to 60% of the sum of operating, supervisory, and maintenance labor, and maintenance materials [12]. Capital recovery cost is based on the anticipated equipment lifetime and the annual interest rate employed. Table 2.9 gives suggested factors for these items.

An economic lifetime of 15 years is assumed for the wet scrubber system. For a 15-year life and an interest rate of 7 percent, the capital recovery factor, CRF, is equal to 0.1098. The system capital recovery cost is then estimated by:

$$CRF = 0.1098 TCI \quad (2.47)$$

**Table 2.9:** Annual Cost Factors for Scrubbers [12]

<b>Cost Item</b>	<b>Factor</b>
<b>Direct Annual Costs, DC</b>	
Operating labor	
Operator	2 to 8 hours per shift
Supervisor	15% of operator
Maintenance	
Labor	1 to 2 hours per shift
Material	100% of maintenance labor
Utilities,	(consumption rate) x (hours/yr) x (unit cost)
Fan	
Pump	
Water	
Operating materials	Application specific
Wastewater disposal	Application specific
<b>Indirect Annual Costs, IC</b>	
Administrative charges	2% of Total Capital Investment
Property tax	1% of Total Capital Investment
Insurance	1% of Total Capital Investment
Overhead	60% of total labor and material costs
Capital recovery	0.1098 x Total Capital Investment
<b>Total Annual Cost</b>	<b>DC + IC</b>

## 2.7 Example Problem

Sludge incinerators frequently employ wet scrubbers for particulate emissions control. The furnace is generally a multiple-hearth or fluid-bed type. Gaseous emissions from the incinerator include carbon monoxide (CO), nitrogen oxides (NO<sub>x</sub>), sulfur oxides (SO<sub>x</sub>), volatile organic compounds (VOC), and hydrogen chloride (HCl). Particulate emissions include ash and heavy metals. Metal oxides will either be adsorbed onto the particulate matter or be free within the gas stream. The free oxides are generally less than 0.5 microns mean particle size and cannot be removed using conventional scrubbers. The moisture content from a sludge incinerator is very high, therefore wet scrubbing is generally employed.

This example is for a multi-hearth sludge incinerator. The inlet conditions to the venturi scrubber are:

volume flow rate	75,000 acfm
inlet temperature	450 °F
moisture content	20%
particulate loading	3 grains/scf
specific density of particulate	1.8

The design parameters for the scrubber are:

required collection efficiency	90% for < 1.0 micron PM
--------------------------------	-------------------------

The particle size distribution for a log-normally distributed incinerator source is given in Table 2.10 and Figure 2.18 presents the plot of the distribution.

**Table 2.10:** Particle Size Distribution for an Sludge Incinerator Source

Particle Size Range (microns)	Median Particle		Cummulative Mass Fraction
	Diameter (microns)	Mass Fraction	
0 - 1	0.50	0.005	0.005
1 - 2.5	1.75	0.195	0.200
2.5 - 4.5	3.50	0.400	0.600
4.5 - 7	5.75	0.300	0.900
7 - 12	9.50	0.080	0.980
> 12	20.00	0.020	1.000

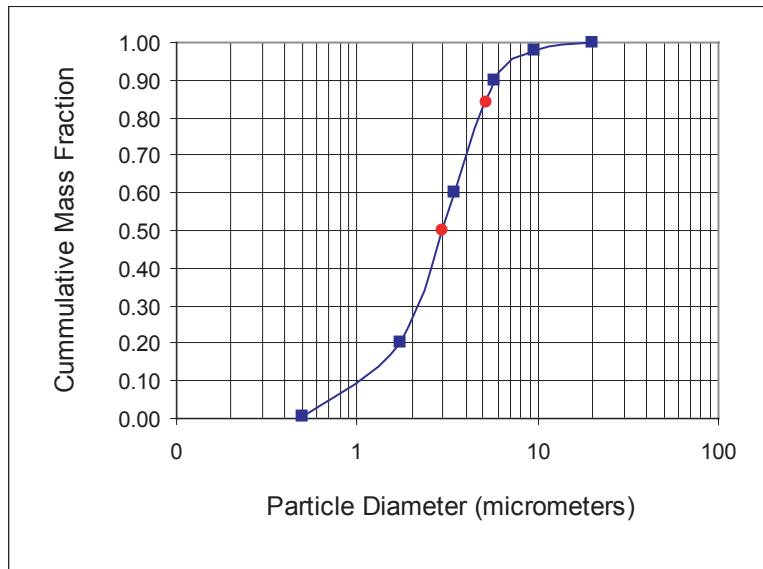

**Figure 2.18:** Particle Size Distribution for Sludge Incinerator

From Figure 2.18 the mass median particle diameter,  $d_{50}$ , and the 84th percentile mass particle diameter,  $d_{84}$ , can be read as:

$$d_{50} = 3$$

$$d_{84} = 5.1$$

Therefore, the standard deviation of the distribution as given by Equation 2.1 is:

$$\sigma = \frac{5.1}{3} = 1.7$$

Now we will calculate the properties of the waste gas at the outlet of the venturi scrubber assuming adiabatic saturation of the waste gas. Using the ideal gas relationship we calculate the volume flow rate of gas at standard conditions. We will use the following information:

molecular weight of water vapor = 18

molecular weight of air = 29

Volume of a lb-mole of air = 385 ft<sup>3</sup>

The waste gas flow rate at standard temperature is:

$$75,000 \text{ acfm} \frac{(70^\circ\text{F} + 460)}{(350^\circ\text{F} + 460)} = 49,074 \text{ scfm}$$

The mass flow rate of dry air and mass of water vapor can be calculated from Equation 2.12 and the molecular weights.

$$\dot{m}_{wv} = 49,074 \text{ scfm} \times 25\% \times \frac{18}{385} = 574 \text{ lb/min of water vapor}$$

$$\dot{m}_a = 49,074 \text{ scfm} \times 75\% \times \frac{29}{385} = 2,772 \text{ lb/min of dry air}$$

The humidity ratio at standard temperature can now be calculated:

$$\omega = \frac{574 \text{ lb/min of dry air}}{2,772 \text{ lb/min of water vapor}} = 0.21$$

From the psychrometric chart given in Figure 2.9, we find the point on the chart for a dry bulb temperature of 350°F and a humidity ratio of 0.21. The line of constant enthalpy (purple) is followed to the left until we reach the 100% relative humidity line (red). This point is at a dry bulb temperature 160°F, a humidity ratio of 0.26, and a humid volume of 22ft<sup>3</sup>/lb.

The waste gas properties at the outlet of the venturi scrubber can now be calculated. The outlet waste gas flow rate is given by Equation 2.13:

$$Q_{m(out)} = 22 \frac{\text{ft}^3}{\text{lb}} \times 2,772 \frac{\text{lb}}{\text{min}} = 60,984 \text{ scfm}$$

The outlet humidity ratio gives the outlet mass flow rate of water vapor as given in Equation 2.14.

$$\dot{m}_{wv(out)} = 2,772 \frac{\text{lb}}{\text{min}} \times .26 = 721 \frac{\text{lb}}{\text{min}}$$

The water evaporated from the scrubbing fluid due to adiabatic saturation of the waste gas stream is calculated from Equation 2.15 as:

$$\dot{m}_{wv(evap)} = 721 \frac{\text{lb}}{\text{min}} - 574 \frac{\text{lb}}{\text{min}} = 147 \frac{\text{lb}}{\text{min}}$$

The volume of makeup water for the recirculation system is then given by Equation 2.16 as:

$$Q_{wv(evap)} = \frac{147 \text{ lb/min}}{62.4 \text{ lb/ft}^3} = 2.4 \text{ cfm} = 18 \text{ gpm}$$

The next step is to size the scrubber. The first parameter to estimate is the pressure drop across the scrubber. We will employ the Calvert Cut Diameter approach. We use Figure 2.13 since the scrubber a venturi and  $B = 2.0$ .

First we need to determine the overall collection efficiency. Assuming the following collection efficiency requirements for each size range, the fraction collection efficiency is calculated from the mass fraction multiplied by the required collection efficiency (Equation 2.4):

Particle Size Range (microns)	Mass Fraction	Required Collection Efficiency	Fractional Collection Efficiency
0 - 1	0.005	0.900	0.0045
1 - 2.5	0.195	0.950	0.185
2.5 - 4.5	0.400	0.980	0.392
4.5 - 7	0.300	0.990	0.297
7 - 12	0.080	1.000	0.080
> 12	0.020	1.000	0.020
<b>Overall Collection Efficiency</b>			<b>0.979</b>

Note that particles greater than 5 microns are assumed to be captured at 100% efficiency for a venturi scrubber.

Reading the graph in Figure 2.13 for the following point:

$$\sigma = 1.7$$

$$Pt = 1 - \eta_d = 0.02$$

We obtain a value for the cut ratio and then calculate cut diameter:

$$\frac{d_{cut}}{d_{50}} \approx 0.2$$

$$d_{cut} = 0.2 \times 3 = 0.6$$



From Figure 2.14, a venturi scrubber with a pressure drop of approximately 15 in of water column with a scrubber power of 4.5 hp per 1,000 ft<sup>3</sup>/min is sufficient. Using Figure 2.6, the approximate venturi scrubber pressure drop is estimated at 12 in. of water column.

Now we can use this estimated pressure drop to size the rest of the venturi. Using Figure 3.10 and assuming a L/G of 10 gal per 1,000 acfm we obtain an approximate throat velocity of 320 ft/s. Using equation 2.17, we can estimate the velocity at the throat. We need the density of air at saturation which is the inverse of the humid volume:

$$HP_{fan} = \frac{15 \text{ in water} \times 75,000 \text{ acfm}}{6356 \times 0.6} = 294 \text{ hp}$$

The brake horsepower of the pump is calculated from Equation 2.36. First we must calculate the specific gravity of the scrubbing liquid. Assuming the scrubbing liquid is water and the specific gravity of the PM is 1.8 we can estimate the specific gravity of the slurry as:

$$\gamma_{slurry} = \frac{\% \text{ solids} + \% \text{ water}}{\frac{\% \text{ solids}}{\gamma_{PM}} + \frac{\% \text{ water}}{\gamma_{water}}} = \frac{25 + 75}{\frac{25}{1.8} + \frac{75}{1.0}} = 1.125$$

We have a throat length of 13.5 ft and a diverging section of 18 ft, resulting in a total length of 31.5 ft. Therefore we can assume the pump must be sized for 40 ft of water column. This gives the power for the pump as:

$$HP_{pump} = \frac{40 \text{ ft} \times 10 \frac{\text{gal}}{1000 \text{ acfm}} \times \frac{75,000 \text{ acfm}}{1000} \times 1.125}{3952.6 \times 0.5} = 17 \text{ hp}$$

We now move on to estimating capital costs for the venturi scrubber. The venturi must be sized for the saturated flow rate of 60,984 acfm. The pressure drop required is 15 in of water, therefore, a low energy venturi is sufficient. The material of construction must be Stainless Steel, 304 L since the waste gas stream contains corrosives. Applying the materials multiplier to the equipment cost equation gives:

$$\text{Venturi EC} = 1.10 \left[ 150 \times 61,000^{0.56} \right] = \$78,950$$

This value must be increased by 80% to 100% to account for the cost of pumps, an upgraded ID fan, piping, valves, instrumentation and control. A moderate level of automation is assumed to be required, therefore the basic equipment cost is increased by 90% to account for the additional equipment:

$$Total\ EC = \$78,950 (1.0 + 0.9) = 150,000$$

Adding additional equipment, taxes, and freight to the basic equipment costs results in the PEC given by:

$$PEC = \$150,000 (1.0 + 0.03 + 0.05) = \$162,000$$

Direct and indirect installation costs are given in Table 2.8. Using these factors, we can calculate TCI as:

$$TCI = \$162,000 (1.0 + 0.56 + 0.35) = \$309,420$$

Assuming the system is a retrofit of low difficulty, we must increase the TCI by a factor of 1.3

$$Retrofit\ TCI = 1.3 (\$309,420) = \$402,250$$

Total annual costs include direct annual costs and indirect annual costs. First we calculate the cost of labor and materials.

$$Operating\ Labor = \frac{3hr}{shift} \times \frac{2shifts}{day} \times \frac{300days}{yr} \times \frac{\$20.00}{hr} = \$39,600\ per\ year$$

$$Supervisory\ Labor = 0.15 \times 39,600 = \$5,940\ per\ year$$

$$Maintenance\ Labor = \frac{1hr}{shift} \times \frac{2shifts}{day} \times \frac{300days}{year} \times \frac{\$20.00}{hr} = \$13,200\ per\ year$$

$$AC_{labor} = \$39,000 + \$5,940 + \$13,200 = \$58,740\ per\ year$$

$$AC_{materials} = 100\% (\$132,000) = \$13,200\ per\ year$$

Next we calculate the cost of utilities.

$$AC_{elect} = 0.7457 \frac{kW}{hp} \times (294hp + 17hp) \times \frac{330days}{yr} \times \frac{16hr}{day} \times \frac{\$0.07}{kWh} = \$85,720 \text{ per year}$$

$$AC_{H2O} = 28gpm \times \frac{330days}{yr} \times \frac{16hr}{day} \times \frac{60min}{hr} \times \frac{\$0.2}{1,000gal} = \$1,770 \text{ per year}$$

So the total direct annual costs is the sum of these costs:

$$DAC = \$58,740 + \$13,200 + \$85,720 + 1,770 = \$159,430 \text{ per year}$$

Indirect annual costs include overhead, administrative charges, property taxes, insurance and the capital recovery factor. The following table details these costs.

<b>Indirect Annual Cost</b>	<b>Factor</b>	<b>Cost per year</b>	
Overhead Costs 60%	$(AC_{labor} + AC_{materials})$	0.60 (\$58,740+\$13,200) =	\$43,160
Administrative Costs	2% TCI	0.02 (\$402,250) =	\$8,050
Property Taxes	1% TCI	0.01 (\$402,250) =	\$4,020
Insurance	1% TCI	0.01 (\$402,250) =	\$4,020
Capital Recovery	0.1098 TCI	0.1098 (\$402,250) =	\$44,170
<b>Total IAC</b>			<b>\$103,420</b>

The total annual cost is the sum of direct and indirect annual costs given by:

$$TAC = \$159,430 + \$103,420 = \$262,850 \text{ per year}$$

## 2.8 Acknowledgments

We gratefully acknowledge the following companies for contributing data to this section:

- Bionomic Industries, Inc (Mahwah, NJ)
- Croll-Reynolds (Westfield, NJ)
- Misonix, Inc. (Farmingdale, NY)

## References

- [1] Schiffner, K.C. and H.E. Hesketh, *Wet Scrubbers* (2nd Edition), Technomic Publishing, Lancaster, PA, 1996.
- [2] Davis, W.T. Ed., *Air Pollution Engineering Manual* (2nd Edition), Air and Waste Management, John Wiley & Sons, Inc., New York, 2000.
- [3] Environmental Protection Agency, U.S. (EPA), "Stationary Source Control Techniques Document for Fine Particulate", EPA Document No. EPA-452/R-97-001, Office of Air Quality Planning and Standards, Research Triangle Park, NC, September 30, 1997.
- [4] Wark, K., C.F. Warner, and W.T. Davis, *Air Pollution: Its Origin and Control* (3rd Edition), Addison-Wesley, Reading, MA, 1998.
- [5] Cooper, C.D. and F.C. Alley, *Air Pollution Control: A Design Approach*, Waveland Press, Inc., Prospect Heights, IL, 1994.
- [6] Environmental Protection Agency, U.S. (EPA), *Air Pollution Technology Fact Sheet*, Office of Air Quality Planning and Standards, Research Triangle Park, NC, 1990.
- [7] Avallone, E. and T. Baumeister, *Mark's Standard Handbook for Mechanical Engineers*, McGraw Hill, New York, 1996.
- [8] *The Scrubber Manual* (Revised), The McIlvaine Company, Northbrook, IL, 1995.
- [9] Advanced Air Technologies, Inc., technical information on scrubbers, [www.aatinc.com/scrubbing\\_zone.htm](http://www.aatinc.com/scrubbing_zone.htm), 2002.
- [10] William L. Heuman, *Industrial Air Pollution Control Systems*, McGraw-Hill, Washington D.C., 1997.
- [11] "Air Pollution Control Systems for Boilers and Incinerators", U.S. Army Technical Manual, TM 5-815-1/AFR 19-6, May 9, 1998.
- [12] Vatauvuk, William, *Estimating Costs of Air Pollution Control*, Lewis Publishers, Chelsea Michigan, 1990.
- [13] Cheremisinoff, Paul. N., Ed., *Air Pollution Control and Design for Industry*, Marcel Dekker, Inc., New York, 1993.
- [14] Theodore, Louis and Anthony Buonicore, Ed., *Air Pollution Control Equipment: Selection, Design, Operation, and Maintenance*, Prentice-Hall, Inc. Englewood Cliffs, New Jersey, 1982.

- [15] Calvert, S., J. Goldsmith, G. Leith, and D. Metha, "Scrubber Handbook", NTIS, Springfield, VA, 1972
- [16] Hesketh, H.E., "Fine Particulate Collection Efficiency Related to Pressure Drop, Scrubbant and Particle Properties, and Contact Mechanisims," *Journal of Air Pollution Control Association*, vol. 24, no. 10, 1974.
- [17] Lapple, C.E. and H.J. Kamack, "Performance of Wet Dust Scrubbers", *Chemical Engineering Progress*, vol. 51, March 1955.
- [18] Semrau, K.T., "Dust Scrubber Design - A Critique on the State of the Art," , " *Journal of Air Pollution Control Association*, vol.13, December 1963.
- [19] Semrau, K.T., "Practical Process Design of Particulate Scrubbers", in *Industrial Air Pollution Engineering*, V. Casaseno, ed., McGraw Hill, New York, 1980.
- [20] "Scrubber Selection Guide", Calvert Environmental Equipment, San Diego, 1988.
- [21] Schnelle, Karl B. Jr. and Charles A. Brown, *Air Pollution Control Technology Handbook*, CRC Press, Washington D.C., 2002.
- [22] Schiffner, Kenneth C. *Air pollution Control Equipment Selection Guide*, Lewis Publishers, Washington D.C., 2002.
- [23] Calvert, S., How to choose a particulate scrubber, *Chem. Eng.*, 54-68, August 29, 1977.
- [24] Personal correspondence from Ken Schiffner of Bionomic Industries, Inc., to Paula Hemmer, E.H. Pechan and Associates, Inc., June, 2002.

## TECHNICAL REPORT DATA

*(Please read Instructions on reverse before completing)*

1. REPORT NO. <b>452/B-02-001</b>	2.	3. RECIPIENT'S ACCESSION NO.
4. TITLE AND SUBTITLE  The EPA Air Pollution Control Cost Manual	5. REPORT DATE <b>January, 2002</b>	
	6. PERFORMING ORGANIZATION CODE	
7. AUTHOR(S) <b>Daniel Charles Mussatti</b>	8. PERFORMING ORGANIZATION REPORT NO.	
9. PERFORMING ORGANIZATION NAME AND ADDRESS <b>U.S. Environmental Protection Agency Office of Air Quality Planning and Standards Air Quality Standards and Strategies Division Innovative Strategies and Economics Group Research Triangle Park, NC 27711</b>	10. PROGRAM ELEMENT NO.	
	11. CONTRACT/GRANT NO.	
12. SPONSORING AGENCY NAME AND ADDRESS  <b>Director Office of Air Quality Planning and Standards Office of Air and Radiation U.S. Environmental Protection Agency Research Triangle Park, NC 27711</b>	13. TYPE OF REPORT AND PERIOD COVERED <b>Final</b>	
	14. SPONSORING AGENCY CODE <b>EPA/200/04</b>	
15. SUPPLEMENTARY NOTES <b>Updates and revises EPA 453/b-96-001, OAQPS Control Cost Manual, fifth edition (in English only)</b>		
16. ABSTRACT <b>In Spanish, this document provides a detailed methodology for the proper sizing and costing of numerous air pollution control devices for planning and permitting purposes. Includes costing for volatile organic compounds (VOCs); particulate matter (PM); oxides of nitrogen (NOx); SO<sub>2</sub>, SO<sub>3</sub>, and other acid gasses; and hazardous air pollutants (HAPs).</b>		
17. KEY WORDS AND DOCUMENT ANALYSIS		
a. DESCRIPTORS	b. IDENTIFIERS/OPEN ENDED TERMS	c. COSATI Field/Group
<b>Economics Cost Engineering cost Sizing Estimation Design</b>	<b>Air Pollution control Incinerators Absorbers Adsorbers Filters Condensers Electrostatic Precipitators Scrubbers</b>	
18. DISTRIBUTION STATEMENT  <b>Release Unlimited</b>	19. SECURITY CLASS ( <i>Report</i> ) <b>Unclassified</b>	21. NO. OF PAGES <b>1,400</b>
	20. SECURITY CLASS ( <i>Page</i> ) <b>Unclassified</b>	22. PRICE